

Threaded fittings



Festo core product range
Covers 80% of your automation tasks

Worldwide:

Always in stock

Superb:

Festo quality at an attractive price

Easy:

Reduces procurement and storing complexity



Ready for dispatch from the Festo factory in 24 hours
Held in stock in 13 service centres worldwide
More than 2200 products





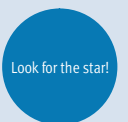



Ready for dispatch in 5 days maximum from stock
Assembled for you in 4 service centres worldwide
Up to 6 x 10¹² variants per product series



Threaded fittings

Product range overview

FESTO

Design	Version	Type	Connection D1			Connection D2			→ Page/ Internet
			M thread	G thread	R thread	M thread	G thread	R thread	
Straight type	Blanking plug								
		B	M3	–	–	–	–	–	3
			M5						
			M7						
			–	G1/8					
				G1/4					
				G3/8					
				G1/2					
				G3/4					
				G1					
Reducing nipple – Male thread/female thread									
	D	M5	–	–	M7	–	–	5	
Double nipple									
	ESK	–	–	R1/8	–	–	R1/8, R1/4, R3/8	5	
				R1/4			R1/4, R3/8, R1/2		
				R3/8			R3/8, R1/2		
				R1/2			R1/2		
Sleeve									
	QM	M5	–	–	–	–	–	6	
		–	G1/8						
			G1/4						
			G3/8						
			G1/2						
			G3/4						
			G1						
L-shape	Elbow fitting								
		LJK	–	G1/8	–	–	–	7	
				G1/4					
				G3/8					
				G1/2					
T-type	T-fitting								
		TJK	M3	–	–	–	–	7	
			–	G1/8					
				G1/4					
				G3/8					
			G1/2						

Threaded fittings

Technical data

FESTO

Blanking plug B

with external hex and sealing ring

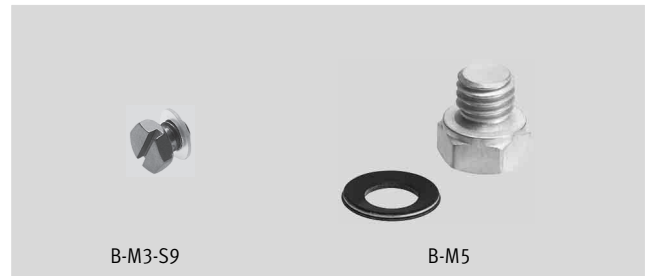

General technical data		
Pneumatic connection	Male thread	
	M3	M5
Type of mounting	External hex AF 4.5 and slot 0.8 mm	External hex AF 7
Nominal tightening torque [Nm]	0.48 ±55%	1.33 ±20%

Materials		
Pneumatic connection	Male thread	
	M3	M5
Blanking plug	High-alloy stainless steel	Anodised aluminium
O-ring	Stainless steel, NBR	
Note on materials	RoHS compliant	
	Free of copper and PTFE	

Dimensions		Download CAD data → www.festo.com
B-M3-S9	B-M5	

Dimensions and ordering data							
Pneumatic connection	L1	L2	≈C1	Weight/ piece [g]	Part No.	Type	PU ¹⁾
D1							
M thread							
Male thread M3	5.3	2.8	4.5	1	★ 30979	B-M3-S9	10
Male thread M5	7.8	3.8	7	1	★ 3843	B-M5	10
					534212	B-M5-100	100

1) Packaging unit quantity

Festo core product range

- ★ Generally ready for shipping ex works in 24 hours
- ☆ Generally ready for shipping ex works in 5 days

Threaded fittings

Technical data

FESTO

Blanking plug B

with internal hex and sealing ring



General technical data								
Pneumatic connection	Male thread							
	M5	M7	G $\frac{1}{8}$	G $\frac{1}{4}$	G $\frac{3}{8}$	G $\frac{1}{2}$	G $\frac{3}{4}$	G1
Type of mounting	Internal hex AF 2.5	Internal hex AF 3	Internal hex AF 5	Internal hex AF 6	Internal hex AF 8	Internal hex AF 10	Internal hex AF 12	Internal hex AF 17
Conforms to standard	–							
Nominal tightening torque [Nm]	1.33 ±20%	3.35 ±20%	3.5 ±20%	11 ±10%	12.5 ±20%	14 ±20%	35 ±10%	62.5 ±20%

Materials								
Pneumatic connection	Male thread							
	M5	M7	G $\frac{1}{8}$	G $\frac{1}{4}$	G $\frac{3}{8}$	G $\frac{1}{2}$	G $\frac{3}{4}$	G1
Blanking plug	Galvanised steel							
O-ring	Stainless steel, NBR		PA, TPE-U(PUR)				PVC	
Note on materials	RoHS compliant							
	Free of copper and PTFE							

Dimensions Download CAD data → www.festo.com

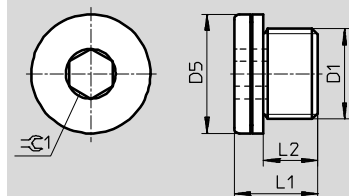

Dimensions and ordering data								
Pneumatic connection	D5	L1	L2	r _{C1}	Weight/ piece [g]	Part No.	Type	PU ¹⁾
D1	∅							
M thread								
Male thread M5	8	6.3	3.8	2.5	1	★ 174308	B-M5-B	10
Male thread M7	9.5	7.8	5.3	3	2	★ 174309	B-M7	10
G thread								
Male thread G $\frac{1}{8}$	14	11	6.4	5	7	★ 3568	B- $\frac{1}{8}$	10
						534213	B- $\frac{1}{8}$ -100	100
Male thread G $\frac{1}{4}$	18	15	9.8	6	15	★ 3569	B- $\frac{1}{4}$	10
						534214	B- $\frac{1}{4}$ -50	50
Male thread G $\frac{3}{8}$	22	15	9.8	8	23	★ 3570	B- $\frac{3}{8}$	10
						534215	B- $\frac{3}{8}$ -20	20
Male thread G $\frac{1}{2}$	26	18	11.65	10	43	★ 3571	B- $\frac{1}{2}$	10
						534216	B- $\frac{1}{2}$ -20	20
Male thread G $\frac{3}{4}$	32	20	13.05	12	76	★ 3572	B- $\frac{3}{4}$	1
Male thread G1	39	21	14	17	123	★ 5763	B-1	1

1) Packaging unit quantity

Festo core product range

- ★ Generally ready for shipping ex works in 24 hours
- ☆ Generally ready for shipping ex works in 5 days

Threaded fittings

Technical data

Reducing nipple D with sealing ring

Material:
Brass

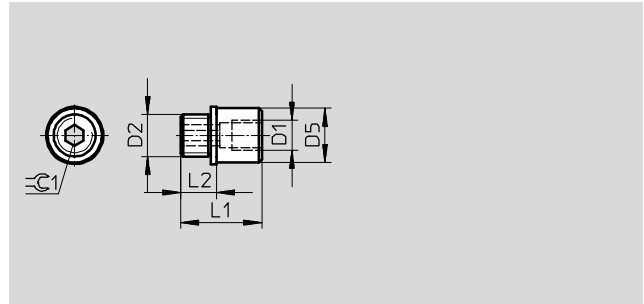

Pneumatic connection		D5	L1	L2	$\approx \text{C} 1$	Weight/ piece [g]	Part No.	Type	PU ¹⁾
D1	D2								
M5	M7	9	13.3	5.3	3	43	161359	D-M5I-M7A-ISK	10

1) Packaging unit quantity

Double nipple ESK adjustable for angular compensation

Material:
Brass

Note on materials:
RoHS-compliant

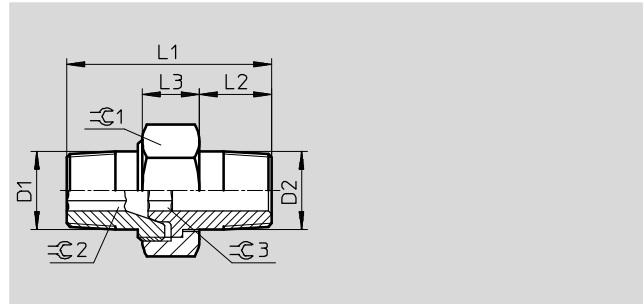

Pneumatic connection		L1	L2	L3	$\approx \text{C} 1$	$\approx \text{C} 2$	$\approx \text{C} 3$	Part No.	Type	PU ¹⁾
D1	D2									
R $\frac{1}{8}$	R $\frac{1}{8}$	27	9	8.5	15	5	5	151520	ESK-$\frac{1}{8}$-$\frac{1}{8}$	1
	R $\frac{1}{4}$	30.6	12	9.5	19	5	6	534151	ESK-$\frac{1}{8}$-$\frac{1}{4}$	1
	R $\frac{3}{8}$	34.5	13	10	22	5	8	534155	ESK-$\frac{1}{8}$-$\frac{3}{8}$	1
R $\frac{1}{4}$	R $\frac{1}{4}$	34	12	9.5	19	6	6	151521	ESK-$\frac{1}{4}$-$\frac{1}{4}$	1
	R $\frac{3}{8}$	36	13	10	22	6	8	534152	ESK-$\frac{1}{4}$-$\frac{3}{8}$	1
	R $\frac{1}{2}$	40.5	16	12	27	6	12	534153	ESK-$\frac{1}{4}$-$\frac{1}{2}$	1
R $\frac{3}{8}$	R $\frac{3}{8}$	36	13	10	22	8	8	151522	ESK-$\frac{3}{8}$-$\frac{3}{8}$	1
	R $\frac{1}{2}$	44	16	12	27	8	12	534154	ESK-$\frac{3}{8}$-$\frac{1}{2}$	1
R $\frac{1}{2}$	R $\frac{1}{2}$	44	16	12	27	12	12	151523	ESK-$\frac{1}{2}$-$\frac{1}{2}$	1

1) Packaging unit quantity

Threaded fittings

Technical data

Pipe coupling sleeve QM

Material:
Blue anodised aluminium
QM-M5-M5:
Steel

Note on materials:
Free of copper and PTFE
RoHS-compliant

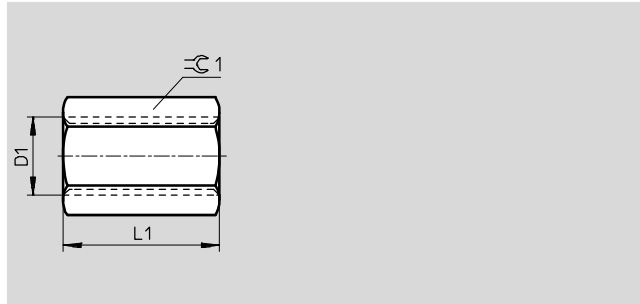
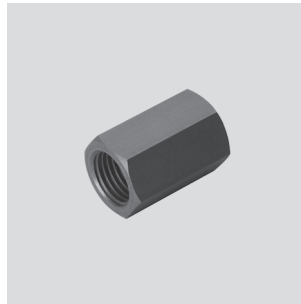

Dimensions and ordering data						
Pneumatic connection	L1	≅ 1	Weight/ piece [g]	Part No.	Type	PU ¹⁾
D1						
M5	12	7	1	3560	QM-M5-M5	10
G ¹ / ₈	22	13	6	2254	QM- ¹ / ₈ - ¹ / ₈	10
G ¹ / ₄	26	17	9	2255	QM- ¹ / ₄ - ¹ / ₄	10
G ³ / ₈	32	22	19	2256	QM- ³ / ₈ - ³ / ₈	10
G ¹ / ₂	36	27	31	2257	QM- ¹ / ₂ - ¹ / ₂	1
G ³ / ₄	36	32	36	4226	QM- ³ / ₄ - ³ / ₄	1
G1	40	41	80	9968	QM-1-1	1

1) Packaging unit quantity

Threaded fittings

Technical data

FESTO

Elbow fitting LJK

Material:
Housing: Die-cast zinc
Hollow bolt: Anodised aluminium

Note on materials:
RoHS-compliant

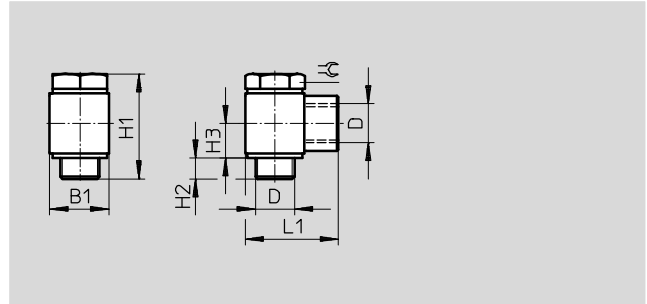

Dimensions and ordering data										
Pneumatic connection	Nominal size [mm]	B1	H1	H2	H3	L1	⌀	Part No.	Type	PU ¹⁾
D										
G ¹ / ₈	4	16	27.1	4.7	9.2	23.5	13	4945	LJK- ¹ / ₈	1
G ¹ / ₄	6	20	34.3	5.7	11.8	31	17	4946	LJK- ¹ / ₄	1
G ³ / ₈	8	25	41.3	6.7	14.3	36.5	22	4947	LJK- ³ / ₈	1
G ¹ / ₂	12	30	46.6	7.5	17.05	44	27	4948	LJK- ¹ / ₂	1

1) Packaging unit quantity

T-fitting TJK

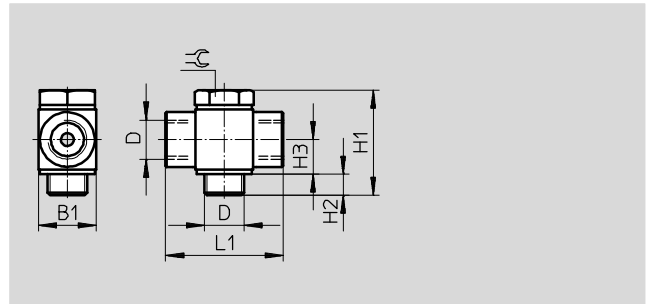

Operating and environmental conditions	
Operating medium	Compressed air in accordance with ISO 8573-1:2010 [7:--:-]
Note on operating/pilot medium	Operation with lubricated medium possible (in which case lubricated operation will always be required)

Materials					
Pneumatic connection	M3	G ¹ / ₈	G ¹ / ₄	G ³ / ₈	G ¹ / ₂
Housing	Nickel-plated brass	Die-cast zinc			
Hollow bolt	Nickel-plated brass	Anodised aluminium			
Note on materials	RoHS-compliant				

Dimensions and ordering data										
Pneumatic connection	Nominal size [mm]	B1	H1	H2	H3	L1	⌀	Part No.	Type	PU ¹⁾
D										
M thread										
M3	1.2	5	10	2	3.3	10	4.5	15874	TJK-M3	10
G thread										
G ¹ / ₈	4	16	27.1	4.7	9.2	28	13	4949	TJK- ¹ / ₈	10
G ¹ / ₄	6	20	34.3	5.7	11.8	39	17	4950	TJK- ¹ / ₄	10
G ³ / ₈	8	25	41.3	6.7	14.3	43	22	4951	TJK- ³ / ₈	1
G ¹ / ₂	12	30	46.6	7.5	17.05	52	27	4952	TJK- ¹ / ₂	1

1) Packaging unit quantity

Festo - Your Partner in Automation



1 Festo Inc.
5300 Explorer Drive
Mississauga, ON L4W 5G4
Canada

Festo Customer Interaction Center
Tel: 1 877 463 3786
Fax: 1 877 393 3786
Email: customer.service.ca@festo.com



2 Festo Pneumatic
Av. Ceylán 3,
Col. Tequesquináhuac
54020 Tlalneantla,
Estado de México

Multinational Contact Center
01 800 337 8669
ventas.mexico@festo.com



3 Festo Corporation
1377 Motor Parkway
Suite 310
Islandia, NY 11749

Festo Customer Interaction Center
1 800 993 3786
1 800 963 3786
customer.service.us@festo.com



4 Regional Service Center
7777 Columbia Road
Mason, OH 45040

Connect with us



www.festo.com/socialmedia



www.festo.com

Subject to change