



Lubricators LOE, D series



Lubricators LOE, D series, metal design

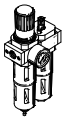
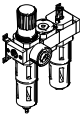
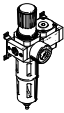

Product range overview D series service units, metal design

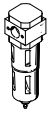
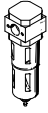
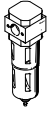
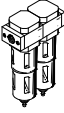
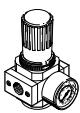
Type	Size	Pneumatic connection										Pressure regulation range [bar]			Grade of filtration [µm]			
		M5	M7	G1/8	G1/4	G3/8	G1/2	G3/4	G1	QS4	QS6	0.5 ...	0.5 ...	2.5 ...	0.01	1	5	40
Service units																		
FRC/FRCS 	Micro	■	■	■	-	-	-	-	-	■	■	■	-	-	-	-	■	-
	Mini	-	-	■	■	■	-	-	-	-	-	■	■	-	-	-	■	■
	Midi	-	-	-	■	■	■	■	-	-	-	■	■	-	-	-	■	■
	Maxi	-	-	-	-	-	■	■	■	-	-	■	■	-	-	-	■	■
Service unit combinations																		
FRC-K 	Micro	-	-	-	-	-	-	-	-	-	-	-	-	-	-	-	-	
	Mini	-	-	■	■	-	-	-	-	-	-	■	■	-	-	-	-	■
	Midi	-	-	-	■	■	■	-	-	-	-	■	■	-	-	-	-	■
	Maxi	-	-	-	-	-	■	■	-	-	-	■	■	-	-	-	-	■
LFR-K LFRS-K 	Micro	-	-	-	-	-	-	-	-	-	-	-	-	-	-	-	-	
	Mini	-	-	■	■	-	-	-	-	-	-	■	■	-	-	-	-	■
	Midi	-	-	-	■	■	■	-	-	-	-	■	■	-	-	-	-	■
	Maxi	-	-	-	-	-	■	■	-	-	-	■	■	-	-	-	-	■
Individual devices																		
Filter regulators LFR/LFRS 	Micro	■	■	■	-	-	-	-	-	■	■	■	-	-	-	-	■	-
	Mini	-	-	■	■	■	-	-	-	-	-	■	■	-	-	-	■	■
	Midi	-	-	-	■	■	■	■	-	-	-	■	■	-	-	-	■	■
	Maxi	-	-	-	-	-	■	■	■	-	-	■	■	-	-	-	■	■
Filters LF 	Micro	■	■	■	-	-	-	-	-	■	■	-	-	-	-	-	■	-
	Mini	-	-	■	■	■	-	-	-	-	-	-	-	-	-	-	■	■
	Midi	-	-	-	■	■	■	■	-	-	-	-	-	-	-	-	■	■
	Maxi	-	-	-	-	-	■	■	■	-	-	-	-	-	-	-	■	■
Fine and micro filters LFMA/LFMB 	Micro	-	-	-	-	-	-	-	-	-	-	-	-	-	-	-	-	-
	Mini	-	-	■	■	■	-	-	-	-	-	-	-	-	■	■	-	-
	Midi	-	-	-	■	■	■	■	-	-	-	-	-	-	■	■	-	-
	Maxi	-	-	-	-	-	■	■	■	-	-	-	-	-	■	■	-	-
Active carbon filters LFX 	Micro	-	-	-	-	-	-	-	-	-	-	-	-	-	-	-	-	-
	Mini	-	-	■	■	■	-	-	-	-	-	-	-	-	-	-	-	-
	Midi	-	-	-	■	■	■	■	-	-	-	-	-	-	-	-	-	-
	Maxi	-	-	-	-	-	■	■	■	-	-	-	-	-	-	-	-	-
Filter combinations LFMBA 	Micro	-	-	-	-	-	-	-	-	-	-	-	-	-	-	-	-	-
	Mini	-	-	■	■	■	-	-	-	-	-	-	-	-	■	■	-	-
	Midi	-	-	-	■	■	■	■	-	-	-	-	-	-	■	■	-	-
	Maxi	-	-	-	-	-	■	■	■	-	-	-	-	-	■	■	-	-
Pressure regulators LR/LRS 	Micro	■	■	■	-	-	-	-	-	■	■	■	-	-	-	-	-	-
	Mini	-	-	■	■	■	-	-	-	-	-	■	■	-	-	-	-	-
	Midi	-	-	-	■	■	■	■	-	-	-	■	■	-	-	-	-	-
	Maxi	-	-	-	-	-	■	■	■	-	-	■	■	-	-	-	-	-

Lubricators LOE, D series, metal design

Product range overview D series service units, metal design

Type	Size	Bowl guard		Condensate drain			Pressure indication		Actuator lock		Supply voltage			Options			→ Page/ Internet
		Metal bowl guard	Plastic bowl	Manual rotary	Semi-automatic	Fully automatic	With pressure gauge	Without pressure gauge	Rotary knob with detent	Rotary knob with integrated lock	24 V DC	110 V AC	230 V AC	Directly actuated pressure regulator with integrated return flow function	Pilot actuated pressure regulator with integrated return flow function	Differential pressure indicator	
Service units																	
FRC/FRCS	Micro	-	■	■	■	-	■	■	■	-	-	-	-	-	-	-	frc
	Mini	■	-	■	-	■	■	■	■	■	-	-	-	-	-	-	
	Midi	■	-	■	-	■	■	■	■	■	-	-	-	-	-	-	
	Maxi	■	-	■	-	■	■	■	■	■	-	-	-	■	■	-	
Service unit combinations																	
FRC-K	Micro	-															frc
	Mini	■	-	■	-	■	■	-	■	-	■	-	-	-	-	-	
	Midi	■	-	■	-	■	■	-	■	-	■	-	-	-	-	-	
	Maxi	■	-	■	-	■	■	-	■	-	■	-	-	■	■	-	
LFR-K LFRS-K	Micro	-															lfr
	Mini	■	-	■	-	■	■	-	■	■	■	-	-	-	-	-	
	Midi	■	-	■	-	■	■	-	■	■	■	-	-	-	-	-	
	Maxi	■	-	■	-	■	■	-	■	■	■	-	-	■	■	-	
Individual devices																	
Filter regulators LFR/LFRS	Micro	-	■	■	■	-	■	■	■	-	-	-	-	-	-	-	lfr
	Mini	■	-	■	-	■	■	■	■	■	-	-	-	-	-	-	
	Midi	■	-	■	-	■	■	■	■	■	-	-	-	-	-	-	
	Maxi	■	-	■	-	■	■	■	■	■	-	-	-	■	■	-	
Filters LF	Micro	-	■	■	■	-	-	-	-	-	-	-	-	-	-	-	lf
	Mini	■	-	■	-	■	-	-	-	-	-	-	-	-	-	-	
	Midi	■	-	■	-	■	-	-	-	-	-	-	-	-	-	-	
	Maxi	■	-	■	-	■	-	-	-	-	-	-	-	-	-	-	
Fine and micro filters LFMA/LFMB	Micro	-															lfma, lfmb
	Mini	■	-	■	-	■	-	-	-	-	-	-	-	-	-	■	
	Midi	■	-	■	-	■	-	-	-	-	-	-	-	-	-	■	
	Maxi	■	-	■	-	■	-	-	-	-	-	-	-	-	-	■	
Active carbon filters LFX	Micro	-															lfx
	Mini	■	-	-	-	-	-	-	-	-	-	-	-	-	-	-	
	Midi	■	-	-	-	-	-	-	-	-	-	-	-	-	-	-	
	Maxi	■	-	-	-	-	-	-	-	-	-	-	-	-	-	-	
Filter combinations LFMBA	Micro	-															lfmba
	Mini	■	-	■	-	■	-	-	-	-	-	-	-	-	-	■	
	Midi	■	-	■	-	■	-	-	-	-	-	-	-	-	-	■	
	Maxi	■	-	■	-	■	-	-	-	-	-	-	-	-	-	■	
Pressure regulators LR/LRS	Micro	-	-	-	-	-	■	■	■	-	-	-	-	-	-	-	lr
	Mini	-	-	-	-	-	■	■	■	■	-	-	-	■	-	-	
	Midi	-	-	-	-	-	■	■	■	■	-	-	-	■	-	-	
	Maxi	-	-	-	-	-	■	■	■	■	-	-	-	■	■	-	

Lubricators LOE, D series, metal design



Product range overview D series service units, metal design

Type	Size	Pneumatic connection										Pressure regulation range [bar]		
		M5	M7	G1/8	G1/4	G3/8	G1/2	G3/4	G1	QS4	QS6	0.5 ... 7	0.5 ... 12	
Individual devices														
Pressure regulators LRB/LRBS		Micro	-											
		Mini	-	-	-	■	-	-	-	-	-	-	■	■
		Midi	-	-	-	-	■	-	-	-	-	-	■	■
		Maxi	-											
Pressure regulator combinations LRB-K		Micro	-											
		Mini	-	-	-	■	■	-	-	-	-	-	■	■
		Midi	-	-	-	-	■	■	-	-	-	-	■	■
		Maxi	-											
Lubricators LOE		Micro	■	■	■	-	-	-	-	-	■	■	-	-
		Mini	-	-	■	■	■	-	-	-	-	-	-	-
		Midi	-	-	-	■	■	■	■	-	-	-	-	-
		Maxi	-	-	-	-	-	■	■	■	-	-	-	-
On-off valves HE		Micro	-											
		Mini	-	-	■	■	■	-	-	-	-	-	-	-
		Midi	-	-	-	■	■	■	■	-	-	-	-	-
		Maxi	-	-	-	-	-	■	■	■	-	-	-	-
On-off valves, electrical HEE		Micro	-											
		Mini	-	-	■	■	■	-	-	-	-	-	-	-
		Midi	-	-	-	■	■	■	■	-	-	-	-	-
		Maxi	-	-	-	-	-	■	■	■	-	-	-	-
On-off valves, pneumatic HEP		Micro	-											
		Mini	-	-	■	■	■	-	-	-	-	-	-	-
		Midi	-	-	-	■	■	■	■	-	-	-	-	-
		Maxi	-	-	-	-	-	■	■	■	-	-	-	-
Soft-start valves HEL		Micro	-											
		Mini	-	-	■	■	■	-	-	-	-	-	-	-
		Midi	-	-	-	■	■	■	■	-	-	-	-	-
		Maxi	-	-	-	-	-	■	■	■	-	-	-	-
Membrane air dryers LDM1		Micro	-											
		Mini	-											
		Midi	-											
		Maxi	-	-	-	-	-	■	■	■	-	-	-	-
Branching modules FRM		Micro	-											
		Mini	-	-	■	■	■	-	-	-	-	-	-	-
		Midi	-	-	-	■	■	■	■	-	-	-	-	-
		Maxi	-	-	-	-	-	■	■	■	-	-	-	-
Distributor block FRZ		Micro	-											
		Mini	-											
		Midi	-											
		Maxi	-											

Lubricators LOE, D series, metal design

Product range overview D series service units, metal design

Type	Size	Bowl guard		Pressure indication		Actuator lock		Supply voltage			Options		→ Page/ Internet
		Metal bowl guard	Plastic bowl	With pressure gauge	Without pressure gauge	Rotary knob with detent	Rotary knob with integrated lock	24 V DC	110 V AC	230 V AC	Non-return function	Pressure switch	
Individual devices													
Pressure regulators LRB/LRBS	Micro	-	-	-	■	■	■	-	-	-	-	-	lrb
	Mini	-	-	-	■	■	■	-	-	-	-	-	
	Midi	-	-	-	■	■	■	-	-	-	-	-	
	Maxi	-	-	-	■	■	■	-	-	-	-	-	
Pressure regulator combinations LRB-K	Micro	-	-	-	■	■	-	-	-	-	-	-	lrb
	Mini	-	-	-	■	■	-	-	-	-	-	-	
	Midi	-	-	-	■	■	-	-	-	-	-	-	
	Maxi	-	-	-	■	■	-	-	-	-	-	-	
Lubricators LOE	Micro	-	■	-	■	-	-	-	-	-	-	-	6
	Mini	■	-	-	■	-	-	-	-	-	-	-	
	Midi	■	-	-	■	-	-	-	-	-	-	-	
	Maxi	■	-	-	■	-	-	-	-	-	-	-	
On-off valves HE	Micro	-	-	-	■	■	-	-	-	-	-	-	he
	Mini	-	-	-	■	■	-	-	-	-	-	-	
	Midi	-	-	-	■	■	-	-	-	-	-	-	
	Maxi	-	-	-	■	■	-	-	-	-	-	-	
On-off valves, electrical HEE	Micro	-	-	-	■	-	-	■	■	■	-	-	hee
	Mini	-	-	-	■	-	-	■	■	■	-	-	
	Midi	-	-	-	■	-	-	■	■	■	-	-	
	Maxi	-	-	-	■	-	-	■	■	■	-	-	
On-off valves, pneumatic HEP	Micro	-	-	-	■	-	-	-	-	-	-	-	hep
	Mini	-	-	-	■	-	-	-	-	-	-	-	
	Midi	-	-	-	■	-	-	-	-	-	-	-	
	Maxi	-	-	-	■	-	-	-	-	-	-	-	
Soft-start valves HEL	Micro	-	-	-	■	-	-	-	-	-	-	-	hel
	Mini	-	-	-	■	-	-	-	-	-	-	-	
	Midi	-	-	-	■	-	-	-	-	-	-	-	
	Maxi	-	-	-	■	-	-	-	-	-	-	-	
Membrane air dryers LDM1	Micro	-	-	-	■	-	-	-	-	-	-	-	ldm1
	Mini	-	-	-	■	-	-	-	-	-	-	-	
	Midi	-	-	-	■	-	-	-	-	-	-	-	
	Maxi	■	-	-	■	-	-	-	-	-	-	-	
Branching modules FRM	Micro	-	-	-	■	-	-	-	-	-	■	■	frm
	Mini	-	-	-	■	-	-	-	-	-	■	■	
	Midi	-	-	-	■	-	-	-	-	-	■	■	
	Maxi	-	-	-	■	-	-	-	-	-	■	■	
Distributor block FRZ	Micro	-	-	-	■	-	-	-	-	-	-	-	frz
	Mini	-	-	-	■	-	-	-	-	-	-	-	
	Midi	-	-	-	■	-	-	-	-	-	-	-	
	Maxi	-	-	-	■	-	-	-	-	-	-	-	

Lubricators LOE, D series, metal design



Peripherals overview

Micro

Individual unit with connection plates,
connection size G $\frac{1}{8}$, QS4 or QS6

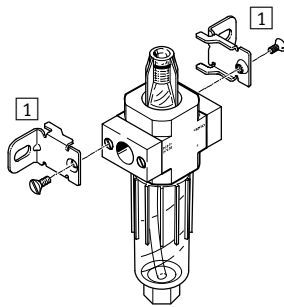

Individual unit without connection plates, for service unit combination
connection thread M5 or M7 in housing

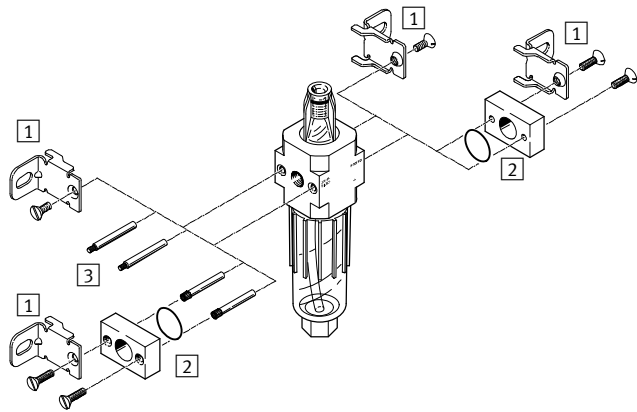

Mounting attachments and accessories					
	Individual unit		Combination		→ Page/ Internet
	with connection plates	without connection plates	with connection plates	without connection plates	
1 Mounting bracket HFOE	■	■	■	■	hfoe-d
2 Connecting plate kit PBL	-	■	-	■	pbl
3 Threaded pin FRB	-	-	■	■	frb-d

Mini/Midi/Maxi

Individual unit with connection plates

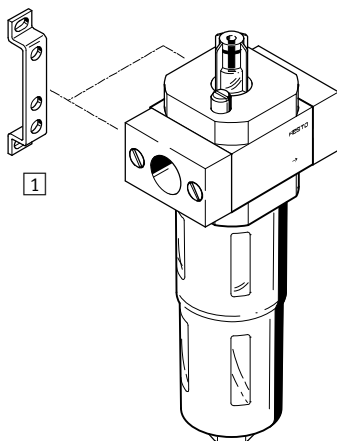

Individual unit without connection plates, for service unit combination

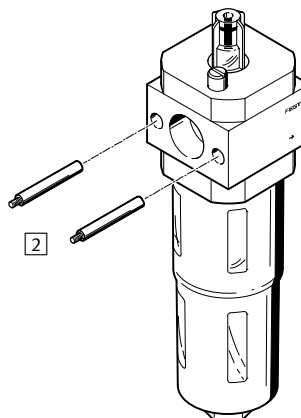

Mounting attachments and accessories					
	Individual unit		Combination		→ Page/ Internet
	with connection plates	without connection plates	with connection plates	without connection plates	
1 Mounting bracket HFOE	■	-	■	-	hfoe-d
2 Threaded pin (included in scope of delivery) FRB	-	-	■	■	frb-d

Lubricators LOE, D series, metal design

Type codes

LOE	–	1/4	–	D	–	MIDI
Basic function						
LOE	Lubricator					
Pneumatic connection						
MINI/MIDI/MAXI						
	Without connecting plates					
MICRO						
M5	Connecting thread M5 in housing					
M7	Connecting thread M7 in housing					
1/8	Connecting plates with connecting thread G1/8					
QS4	Connecting plates with push-in connector QS-4					
QS6	Connecting plates with push-in connector QS-6					
MINI						
1/8	Connecting plates with connecting thread G1/8					
1/4	Connecting plates with connecting thread G1/4					
3/8	Connecting plates with connecting thread G3/8					
MIDI						
1/4	Connecting plates with connecting thread G1/4					
3/8	Connecting plates with connecting thread G3/8					
1/2	Connecting plates with connecting thread G1/2					
3/4	Connecting plates with connecting thread G3/4					
MAXI						
1/2	Connecting plates with connecting thread G1/2					
3/4	Connecting plates with connecting thread G3/4					
1	Connecting plates with connecting thread G1					
Series						
D	Series					
Size						
MICRO	Grid dimension 25 mm (without connecting plates)					
MINI	Grid dimension 40 mm (without connecting plates)					
MIDI	Grid dimension 55 mm (without connecting plates)					
MAXI	Grid dimension 66 mm (without connecting plates)					



Lubricators LOE, D series, metal design

Technical data

FESTO

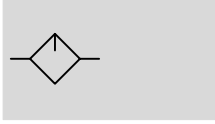
Function



-  - Flow rate
160 ... 9,000 l/min
-  - Temperature range
-10 ... +60 °C
-  - Operating pressure
0 ... 16 bar



The proportional lubricator adds a precision adjustable quantity of oil to the compressed air stream. The pressure drop that occurs when air flows through a Venturi nozzle is used to convey oil from the container

to the drip cap. From here, the oil drips into the air duct directly behind the proportional valve, where it is atomised. The oil mist component is proportional to the compressed air flow rate.

- Proportional lubricator with precision oil metering
- Reduces wear on drive units subject to high loading
- High flow rate
- Quick and easy oil top-up
- Robust metal housing
- Transparent lubricator bowl with metallic bowl guard

The following oils are recommended for Festo components:
Viscosity range to ISO 3448, ISO class VG 32
32 mm²/s (= cSt) at 40 °C

- Festo special oil → 14
- ARAL Vitam GF 32
- BP Energol HLP 32
- Esso Nuto H 32
- Mobil DTE 24
- Shell Tellus Oil DO 32

General technical data				
Size	Micro	Mini	Midi	Maxi
Pneumatic connection 1, 2 ¹⁾	M5 ²⁾ , M7 ²⁾ , G1/8, QS-4 ³⁾ , QS-6 ³⁾	G1/8, G1/4, G3/8, - ⁴⁾	G1/4, G3/8, G1/2, G3/4, - ⁴⁾	G1/2, G3/4, G1, - ⁴⁾
Design	Proportional standard mist lubricator			
Type of mounting	Via accessories			
	In-line installation			
Mounting position	Vertical ±5°			
Air purity class at the output	Compressed air according to ISO 8573-1:2010 [7:4:4]			
	Inert gases			
Bowl guard	- Metal bowl guard			
Minimum flow for lubricator operation [l/min]	3	3	8	10
Max. oil capacity [cm ³]	6.5	45	110	100

1) Connecting plates with connecting thread
 2) Without connecting plates, connecting thread in housing
 3) Connecting plates with push-in connector
 4) Without connecting plates.
 - | - Note: This product conforms to ISO 1179-1 and to ISO 228-1

Lubricators LOE, D series, metal design

Technical data

Standard nominal flow rate ¹⁾ q _{nN} [l/min]					
Size	Micro				
Pneumatic connection 1, 2	M5	M7	G $\frac{1}{8}$	QS-4	QS-6
LOE	200	430	410	160	330

1) Measured at p₁ = 6 bar and Δp = 1 bar.

Standard nominal flow rate q _{nN} ¹⁾ [l/min]										
Size	Mini			Midi				Maxi		
Pneumatic connection 1, 2	G $\frac{1}{8}$	G $\frac{1}{4}$	G $\frac{3}{8}$	G $\frac{1}{4}$	G $\frac{3}{8}$	G $\frac{1}{2}$	G $\frac{3}{4}$	G $\frac{1}{2}$	G $\frac{3}{4}$	G1
LOE	1,300	2,300	2,700	2,800	5,500	6,100	6,300	8,300	8,400	9,000

1) Measured at p₁ = 6 bar and Δp = 1 bar.

Operating and environmental conditions				
Size	Micro	Mini	Midi	Maxi
Operating pressure [bar]	1 ... 10	0 ... 16		
Operating medium	Compressed air in accordance with ISO 8573-1:2010 [7:4:4] Inert gases			
Note on operating/pilot medium	Operation with lubricated medium possible (in which case lubricated operation will always be required)			
Ambient temperature [°C]	-10 ... +60			
Temperature of medium [°C]	-10 ... +60			
Storage temperature [°C]	-10 ... +60			
Corrosion resistance class CRC ¹⁾	2			
Maritime classification	See certificate (pneumatic connection G $\frac{1}{8}$... G1) ²⁾			

1) Corrosion resistance class CRC 2 to Festo standard FN 940070

Moderate corrosion stress. Indoor applications in which condensation may occur. External visible parts with primarily decorative requirements for the surface and which are in direct contact with the ambient atmosphere typical for industrial applications.

2) Additional information www.festo.com/sp → Certificates.

Weight [g]						
Size	Micro		Mini	Midi	Maxi	
	Connecting thread	Connecting plate			Connection G $\frac{1}{2}$, G $\frac{3}{4}$	Connection G1
LOE	39	59	270	630	1,100	1,200

Materials

Sectional view

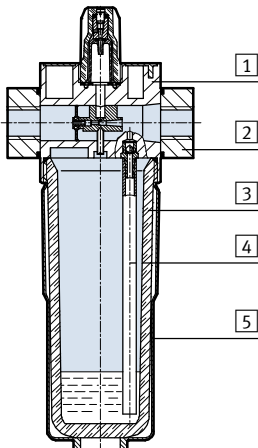

Size	Micro	Mini/Midi/Maxi
1 Housing	Die-cast aluminium	Die-cast zinc/aluminium
2 Connecting plates	Wrought aluminium alloy	Die-cast zinc/aluminium
3 Bowl	PC	
4 Tubing	PE	
5 Metal bowl guard	-	Wrought aluminium alloy
- Seals	NBR	
Note on materials	RoHS-compliant	

Lubricators LOE, D series, metal design

Technical data



Standard flow rate q_n as a function of the differential pressure Δp_{1-2}

LOE-M5-D-MICRO

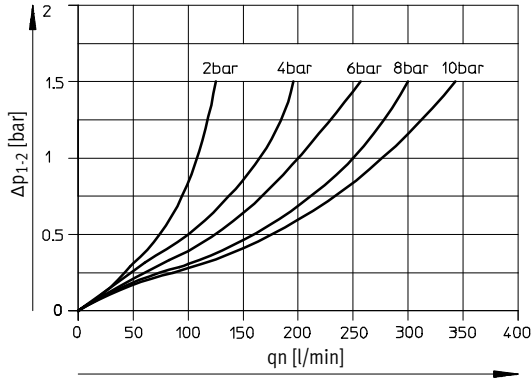

LOE-M7-D-MICRO B

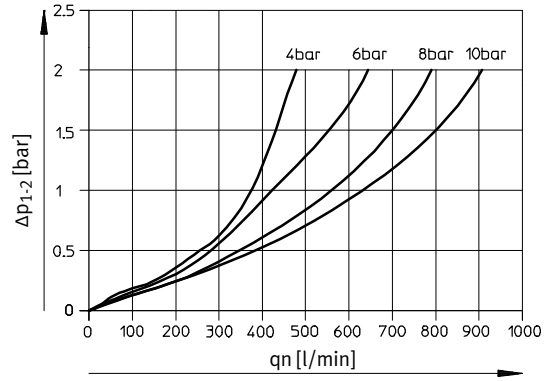

LOE-1/8-D-MICRO

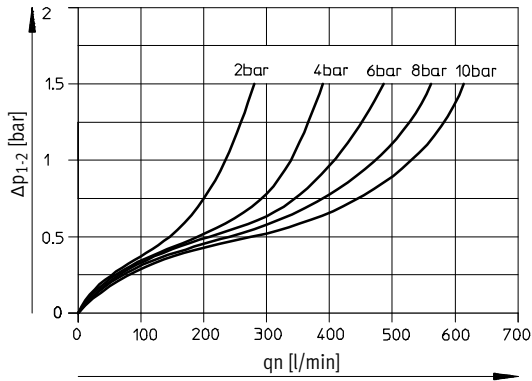

LOE-QS4-D-MICRO

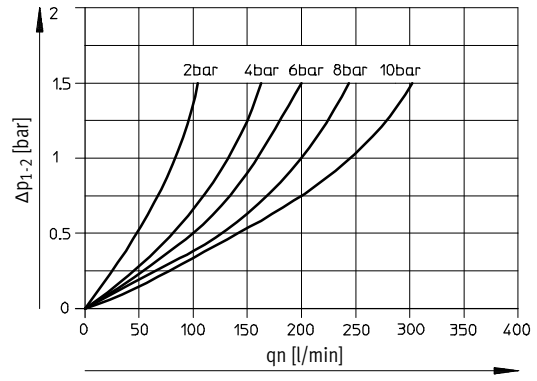

LOE-QS6-D-MICRO

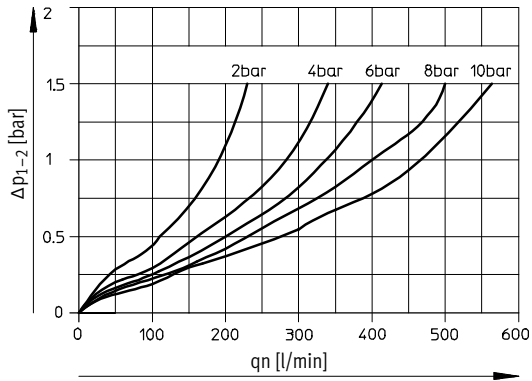

Lubricators LOE, D series, metal design

Technical data



Standard flow rate q_n as a function of the differential pressure Δp_{1-2}

LOE-1/4-D-MINI

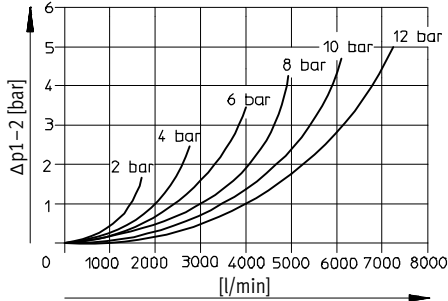

LOE-1/2-D-MIDI

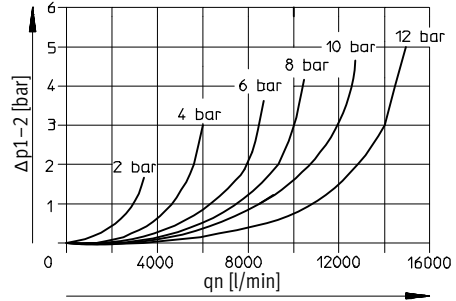

LOE-1-D-MAXI

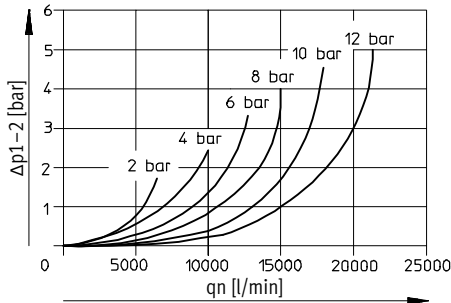

Dimensions – Micro

Download CAD data → www.festo.com

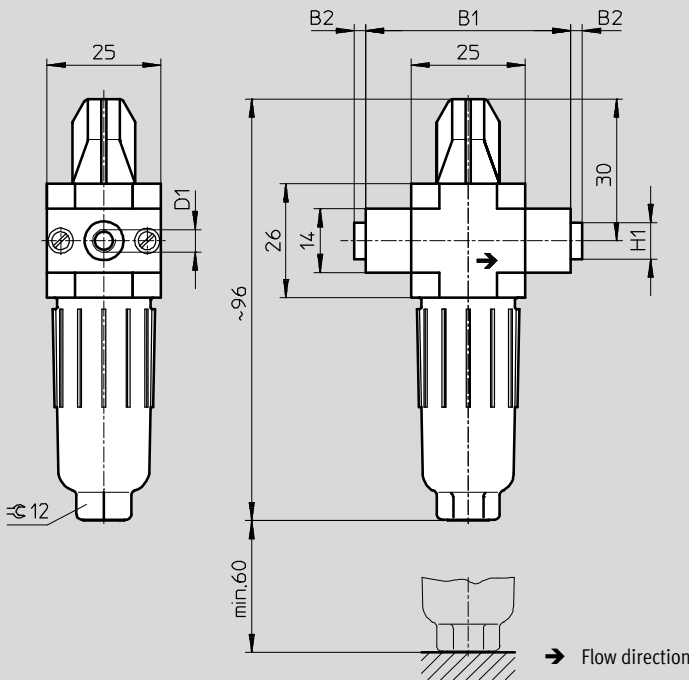

Type	B1	B2	D1	H1
LOE-M5-D-MICRO	25	-	M5	-
LOE-M7-D-MICRO B			M7	
LOE-1/8-D-MICRO	45	~2.5	G1/8	~8
LOE-QS4-D-MICRO			QS-4	
LOE-QS6-D-MICRO			QS-6	

• Note: This product conforms to ISO 1179-1 and to ISO 228-1

Lubricators LOE, D series, metal design

Technical data



Dimensions – Mini/Midi/Maxi Download CAD data → www.festo.com

Connecting plates with connecting thread Without connecting plates

With threaded connecting plates Without threaded connecting plates

2 Metal bowl guard
 4 Threaded pin (exchangeable)
 5 Bleed screw for oil reservoir
 → Flow direction
3 Installation dimensions
 6 Oil adjusting screw

Type	B1	B2	B3	B4	B5	D1	D2 ∅	D3	D6 ∅	H1	H2	L1	L2	L3	T1	T2	⊕ 2
Mini																	
LOE-1/8-D-MINI	64	52	40	30	-	G1/8	-	M4	38	20	11	169	124	100	7	-	22
LOE-1/4-D-MINI						G1/4											
LOE-3/8-D-MINI	70					G3/8											
LOE-D-MINI	-	-			5.8	-	11								-	10	
Midi																	
LOE-1/4-D-MIDI	85	70	55	43	-	G1/4	-	M5	52	32	22	204	151	120	8	-	24
LOE-3/8-D-MIDI						G3/8											
LOE-1/2-D-MIDI						G1/2											
LOE-3/4-D-MIDI						G3/4											
LOE-D-MIDI	-	-			6.8	-	24								-	11	
Maxi																	
LOE-1/2-D-MAXI	96	80	66	46	-	G1/2	-	M5	65	32	22	228	170	150	8	-	24
LOE-3/4-D-MAXI						G3/4											
LOE-1-D-MAXI	116	91				G1											
LOE-D-MAXI	-	-			6.8	-	30								-	11	

|| - Note: This product conforms to ISO 1179-1 and to ISO 228-1

Lubricators LOE, D series, metal design

Technical data

Ordering data – Micro			
Size	Connection	Part No.	Type
Without connecting plates, connecting thread in housing			
Micro	M5	526309	LOE-M5-D-MICRO
	M7	534188	LOE-M7-D-MICRO-B
Connecting plates with connecting thread			
Micro	G1/8	526310	LOE-1/8-D-MICRO
Connecting plates with push-in connector			
Micro	QS-4	526313	LOE-QS4-D-MICRO
	QS-6	526314	LOE-QS6-D-MICRO

Ordering data – Mini/Midi/Maxi			
Size	Connection	Part No.	Type
Without connecting plates			
Mini	–	192575	LOE-D-MINI
Midi	–	192576	LOE-D-MIDI
Maxi	–	192577	LOE-D-MAXI
Connecting plates with connecting thread			
Mini	G1/8	159620	LOE-1/8-D-MINI
	G1/4	159621	LOE-1/4-D-MINI
	G3/8	162680	LOE-3/8-D-MINI
Midi	G1/4	186479	LOE-1/4-D-MIDI
	G3/8	159586	LOE-3/8-D-MIDI
	G1/2	159587	LOE-1/2-D-MIDI
	G3/4	162681	LOE-3/4-D-MIDI
Maxi	G1/2	186480	LOE-1/2-D-MAXI
	G3/4	159622	LOE-3/4-D-MAXI
	G1	159623	LOE-1-D-MAXI

Lubricators LOE, D series

Accessories

FESTO

Special oil



Ordering data		
Scope of delivery	Part No.	Type
1 litre	152811	OFSW-32

Festo - Your Partner in Automation



1 Festo Inc.
5300 Explorer Drive
Mississauga, ON L4W 5G4
Canada

Festo Customer Interaction Center
Tel: 1 877 463 3786
Fax: 1 877 393 3786
Email: customer.service.ca@festo.com



2 Festo Pneumatic
Av. Ceylán 3,
Col. Tequesquináhuac
54020 Tlalneptla,
Estado de México

Multinational Contact Center
01 800 337 8669
ventas.mexico@festo.com



3 Festo Corporation
1377 Motor Parkway
Suite 310
Islandia, NY 11749

Festo Customer Interaction Center
1 800 993 3786
1 800 963 3786
customer.service.us@festo.com



4 Regional Service Center
7777 Columbia Road
Mason, OH 45040

Connect with us



www.festo.com/socialmedia



www.festo.com

Subject to change