

Radial grippers DHRS



# Radial grippers DHRS

Key features



## At a glance

### General information

- Lateral gripper jaw support for high torque loads
- Self-centring
- Gripper jaw centring options
- Max. repetition accuracy
- Gripping force retention
- Internal fixed flow control
- Wide range of options for mounting on drive units

- Sensor technology:
  - Adaptable position sensor for the small gripper sizes
  - Integratable proximity sensors for the medium and large gripper sizes

### Flexible range of applications

- Can be used as a double-acting and single-acting gripper
- Compression spring for supplementary or retaining gripping forces
- Suitable for external and internal gripping

## The technology in detail

### Gripper closed

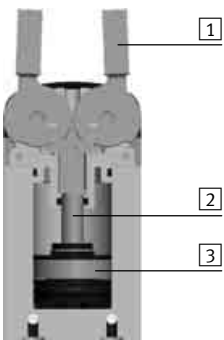

### Gripper open

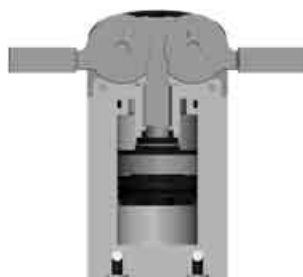

- 1 Gripper jaw
- 2 Slotted guide plate
- 3 Piston with magnet



Note

Gripper selection  
sizing software

→ [www.festo.com](http://www.festo.com)

## Position sensing/force control

### With position transmitter SMAT-8M, SDAT



Analogue positional feedback possible

- Analogue output
  - 0 ... 10 V
  - 4... 20 mA

### With proportional pressure regulator VPPM



Infinite adjustment of the gripping force possible

- Setpoint input
  - 0 ... 10 V
  - 4 ... 20 mA

### With proximity sensor SMT-8G



Multiple positions can be sensed:

- Open
- Closed
- Workpiece gripped

# Radial grippers DHRS

Key features

## Supply ports

At the side

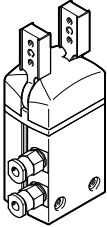

## Mounting options

At the side

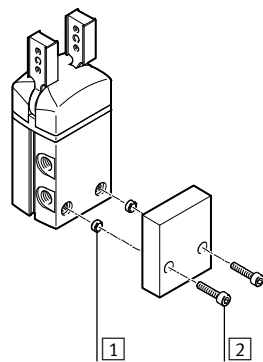
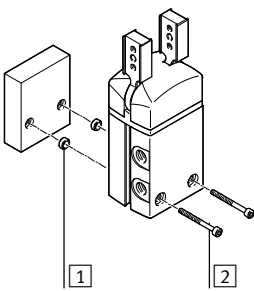

From underneath

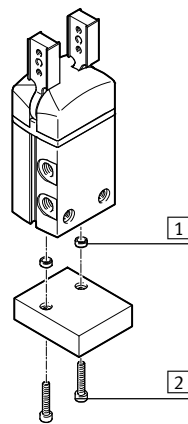

- 1 Centring sleeves
- 2 Mounting screws

## Mounting options for external gripper fingers

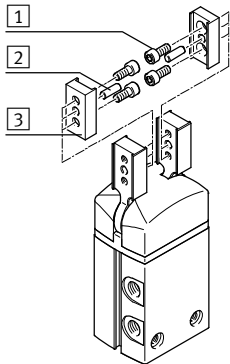

- 1 Mounting screws
- 2 Centring pins
- 3 Gripper fingers

- Note

These grippers are not designed for the following or similar sample applications:

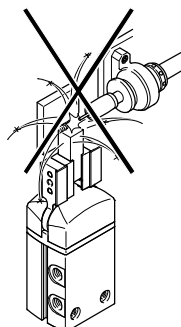

- Welding spatter

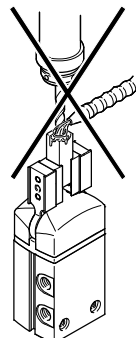

- Machining
- Aggressive media

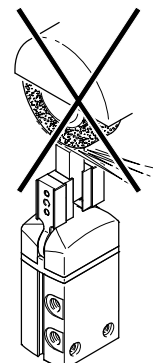

- Grinding dust

# Radial grippers DHRS

Peripherals overview

## Peripherals overview

DHRS-10

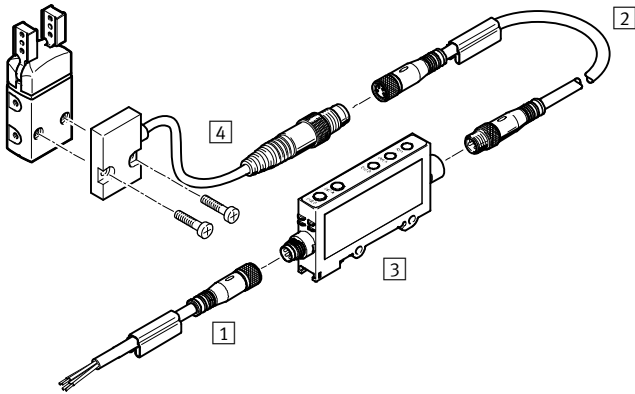

DHRS-16 ... 40

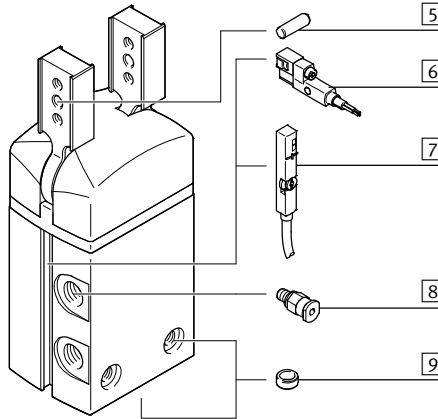

## System product for handling and assembly technology

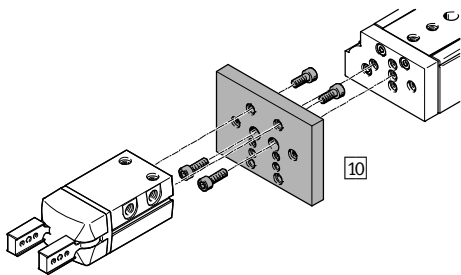

## Proportional pressure regulator VPPM

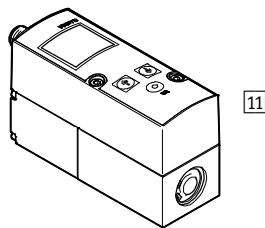

# Radial grippers DHRS

Peripherals overview

Accessories			
Type	Size	Description	→ Page/Internet
1 Connecting cable NEBU	10	<ul style="list-style-type: none"> <li>• Connection between signal converter and controller</li> </ul>	20
2 Connecting cable NEBU	10	<ul style="list-style-type: none"> <li>• Connection between position sensor and signal converter</li> </ul>	20
3 Signal converter SVE4	10	<ul style="list-style-type: none"> <li>• For evaluating signals for position sensor SMH-S1</li> </ul>	20
4 Position sensor SMH-S1	10	<ul style="list-style-type: none"> <li>• Adaptable and integratable sensor technology, for sensing the piston position</li> </ul>	20
5 Centring pin	10 ... 40	<ul style="list-style-type: none"> <li>• For centring the gripper fingers on the gripper jaws</li> </ul>	–
6 Proximity sensor SMT-8G	16 ... 40	<ul style="list-style-type: none"> <li>• For sensing the piston position</li> <li>• Proximity sensor does not project past the housing at the bottom</li> </ul>	21
7 Position transmitter SMAT-8M	16 ... 40	<ul style="list-style-type: none"> <li>• Continuously senses the position of the piston. Has an analogue output with an output signal in proportion to the piston position</li> </ul>	21
Position transmitter SDAT	32, 40		
8 Push-in fitting QS	10 ... 40	<ul style="list-style-type: none"> <li>• For connecting compressed air tubing with standard O.D.</li> </ul>	qs
9 Centring sleeve ZBH	10 ... 40	<ul style="list-style-type: none"> <li>• For centring the gripper during mounting</li> <li>• The scope of delivery of the gripper includes 2 centring sleeves</li> </ul>	20
10 Adapter kit DHAA, HMSV, HAPG, HAPS, HMVA	10 ... 40	<ul style="list-style-type: none"> <li>• Connecting plate between drive and gripper</li> </ul>	16
11 Proportional pressure regulator VPPM	10 ... 40	<ul style="list-style-type: none"> <li>• For infinite adjustment of the gripping force</li> </ul>	vppm

# Radial grippers DHRS

Type codes

		DHRS	-	16	-	A	-	
<b>Type</b>								
DHRS	Radial gripper							
<b>Size</b>								
<b>Position sensing</b>								
A	Via proximity sensor							
<b>Gripping force retention</b>								
NC	Closing							

# Radial grippers DHRS

Technical data

FESTO

Function  
Double-acting  
DHRS-...-A

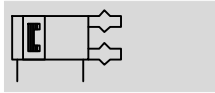

-  Size  
10 ... 40 mm

-  Opening angle  
180°

-  www.festo.com

Function – Variants  
Single-acting or  
with gripping force retention ...  
... closing DHRS-...-NC



General technical data					
Size	10	16	25	32	40
Design	Forced motion sequence				
Mode of operation	Double-acting				
Gripper function	Radial				
Guide	Plain-bearing guide				
Gripping force retention	–	NC	NC	NC	NC
Number of gripper jaws	2				
Opening angle per gripper jaw	[°] 90				
Pneumatic connection	M3	M3	M5	G1/8	G1/8
Repetition accuracy <sup>1)</sup>	[mm] ≤ 0.1				
Max. interchangeability	[mm] ≤ ±0.2				
Max. operating frequency	[Hz] 4			3	
Rotational symmetry	[mm] ≤ ∅ 0.2				
Position sensing	Via position sensor		Via proximity sensor, position transmitter		
Type of mounting	Via through-hole and centring sleeve				
	Via female thread and centring sleeve				
Mounting position	Any				

1) End-position drift under constant conditions of use with 100 consecutive strokes in the direction of movement of the gripper jaws

Operating and environmental conditions					
Size	10	16	25	32	40
Min. operating pressure					
DHRS-...-A	[bar]	2			
DHRS-...-A-NC	[bar]	–	4		
Max. operating pressure	[bar]	8			
Operating medium	Compressed air in accordance with ISO 8573-1:2010 [7:4:4]				
Note on operating/pilot medium	Operation with lubricated medium possible (in which case lubricated operation will always be required)				
Ambient temperature <sup>1)</sup>	[°C]	+5 ... +60			
Corrosion resistance class CRC <sup>2)</sup>		1			

1) Note operating range of proximity sensors

2) Corrosion resistance class CRC 1 to Festo standard FN 940070

Low corrosion stress. For dry indoor applications or transport and storage protection. Also applies to parts behind covers, in the non-visible interior area, and parts which are covered in the application (e.g. drive trunnions).

Weight [g]					
Size	10	16	25	32	40
DHRS-...-A	44	114	270	480	829
DHRS-...-A-NC	–	118	277	490	844

# Radial grippers DHRS

Technical data

## Materials

Sectional view

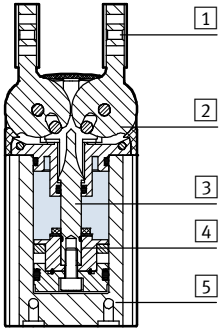

### Radial gripper

1	Gripper jaw	High-alloy stainless steel
2	Cover cap	Polyamide
3	Slotted guide plate	Tempered steel
4	Piston	Polyacetal
5	Housing	Hard anodised wrought aluminium alloy
-	Seals	Nitrile rubber
-	Note on materials	Free of copper and PTFE RoHS-compliant

## Total gripping torque [Ncm] at 6 bar

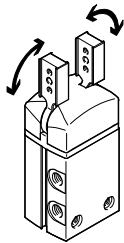

The gripping torque is not constant within the opening angle → page 12.

Size	10	16	25	32	40	
DHRS-...-A	Opening	21	62	233	423	725
	Closing	15	55	215	390	660

## Static characteristic load values at the gripper jaws

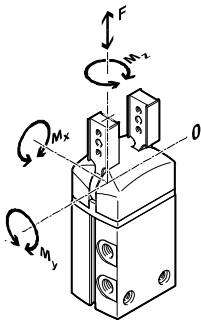

The indicated permissible forces and torques apply to a single gripper jaw. They include the lever arm, additional applied loads due to the workpiece or external gripper fingers and accelera-

tion forces occurring during movement.

The zero coordinate line (gripper jaw guide) must be taken into consideration for the calculation of torques.

Size	10	16	25	32	40	
Max. permissible force $F_z$	[N]	30	40	75	120	200
Max. permissible torque $M_x$	[Nm]	0.8	1.3	3.2	6.2	14
Max. permissible torque $M_y$	[Nm]	0.8	1.3	3.2	6.2	14
Max. permissible torque $M_z$	[Nm]	0.8	1.3	3.2	6.2	14

## Mass moment of inertia [ $\text{kgm}^2 \times 10^{-4}$ ]

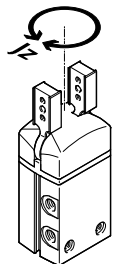

Mass moment of inertia of the radial gripper in relation to the central axis, without external gripper fingers, without load.

Size	10	16	25	32	40
DHRS-...-A	0.03	0.14	0.69	1.66	4.18
DHRS-...-A-NC	-	0.15	0.71	1.69	4.24



# Radial grippers DHRS

Technical data

## Opening and closing times [ms] at 6 bar

Without external gripper fingers

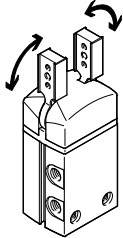

The indicated opening and closing times [ms] were measured at room temperature at an operating pressure of 6 bar with horizontally mounted grippers without additional gripper

fingers (average values). The grippers must be throttled for greater applied loads. Opening and closing times must then be adjusted accordingly.

Size		10	16	25	32	40
Without external gripper fingers						
DHRS...-A	Opening	35	61	102	111	113
	Closing	91	63	105	119	142
DHRS...-A-NC	Opening	-	75	150	131	151
	Closing	-	43	96	88	110

## Opening and closing times t to be set at 6 bar as a function of mass moment of inertia of the gripper fingers

DHRS-10

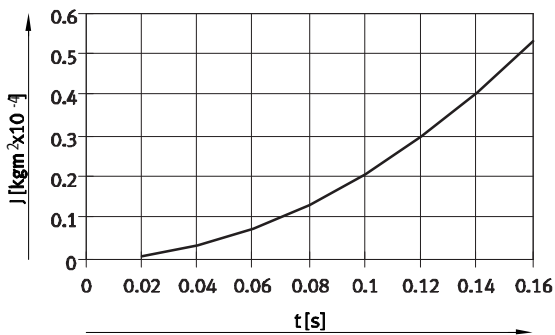

DHRS-16

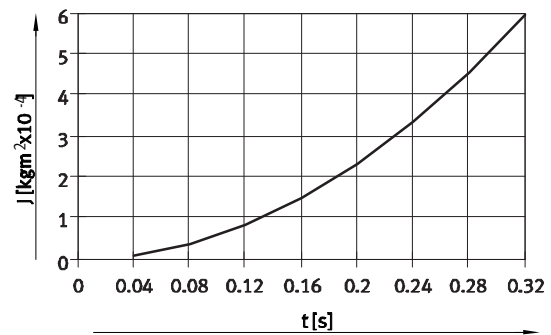

DHRS-25

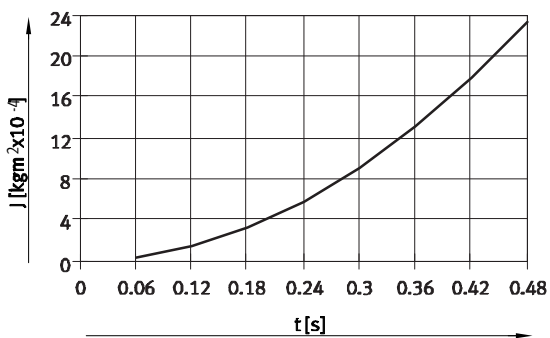

DHRS-32

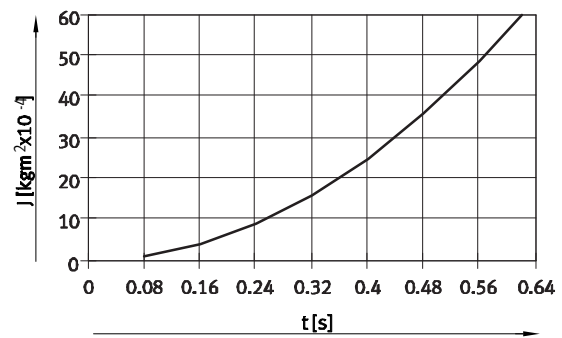

DHRS-40

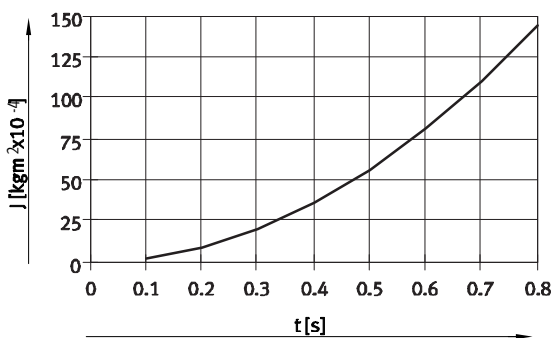

# Radial grippers DHRS

Technical data

## Gripping force $F_H$ per gripper jaw as a function of operating pressure and lever arm $x$

The gripping forces as a function of operating pressure and lever arm can be determined from the following graphs.

The gripping torque is not constant within the opening angle → page 12.

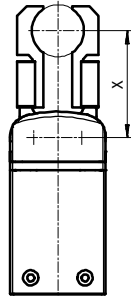

Note  
Gripper selection  
sizing software  
→ [www.festo.com](http://www.festo.com)

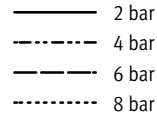

### External gripping (closing)

DHRS-10

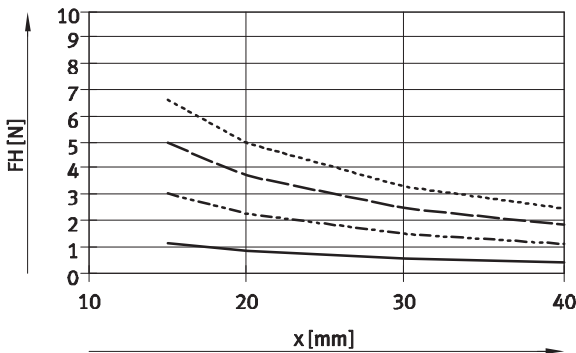

DHRS-16

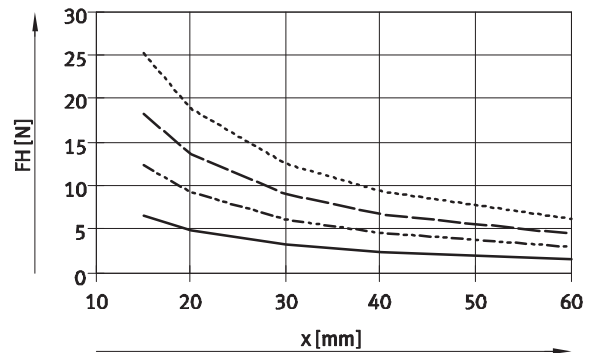

DHRS-25

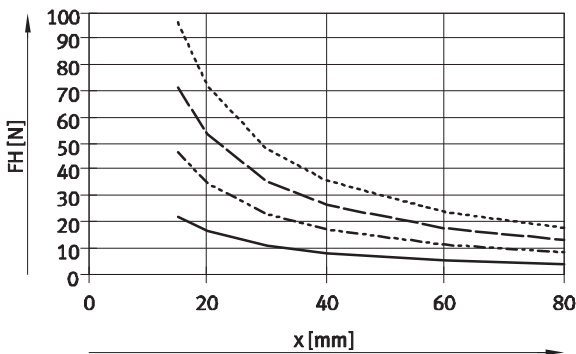

DHRS-32

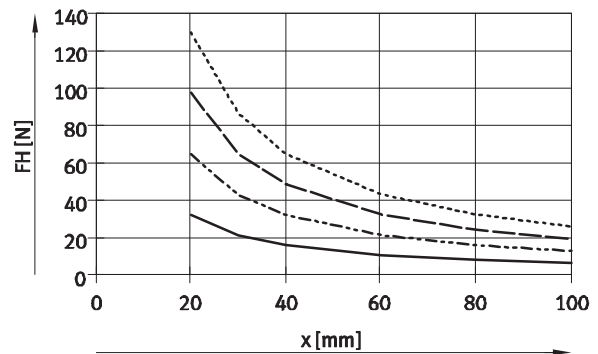

DHRS-40

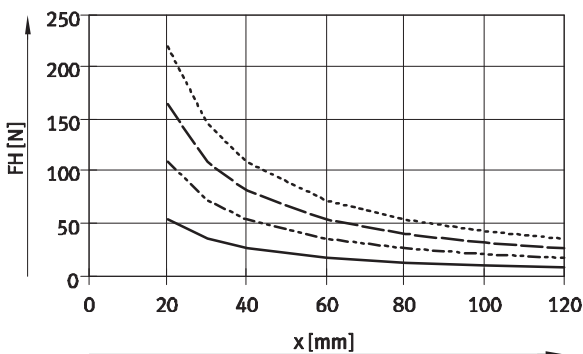

# Radial grippers DHRS

Technical data

## Gripping force $F_H$ per gripper jaw as a function of operating pressure and lever arm $x$

The gripping forces as a function of operating pressure and lever arm can be determined from the following graphs.

The gripping torque is not constant within the opening angle → page 12.

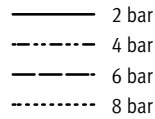
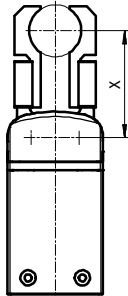

Note  
Gripper selection  
sizing software  
→ [www.festo.com](http://www.festo.com)

### Internal gripping (opening)

DHRS-10

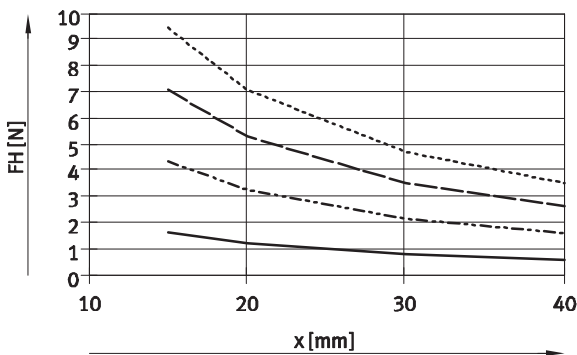

DHRS-16

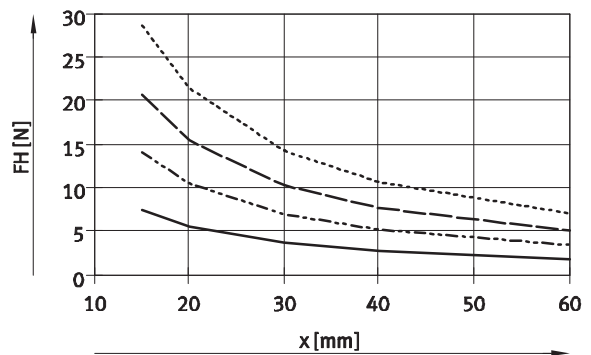

DHRS-25

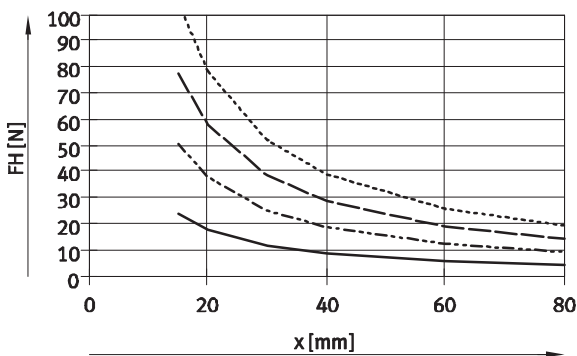

DHRS-32

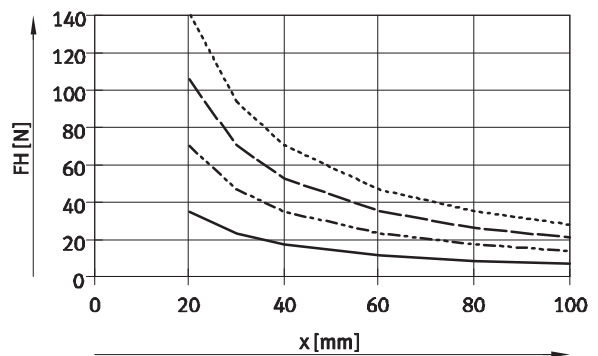

DHRS-40

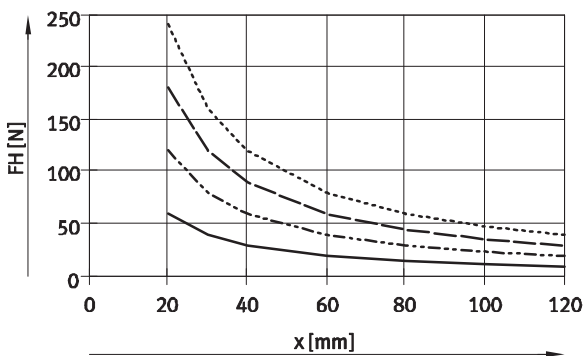

# Radial grippers DHRS

Technical data

## Gripping force $F_H$ per gripper jaw at 6 bar as a function of lever arm $x$ and eccentricity $a$ and $b$

The following formula must be used to calculate the lever arm  $x$  with eccentric gripping:

$$x = \sqrt{a^2 + b^2}$$

The gripping force  $F_H$  can be read from the graphs (→ page 10/11) using the calculated value  $x$ .

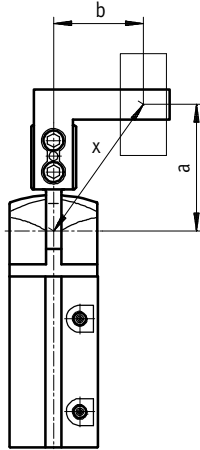

### Calculation example

Given:  
 Distance  $a = 25$  mm  
 Distance  $b = 20$  mm  
 To be calculated:  
 The gripping force at 6 bar, with a DHRS-16, used as an external gripper

Procedure:  
 Calculating the lever arm  $x$   
 $x = \sqrt{25^2 + 20^2}$   
 $x = 32$  mm

The graph (→ page 10) gives a value of  $F_H = 8$  N for the gripping force.

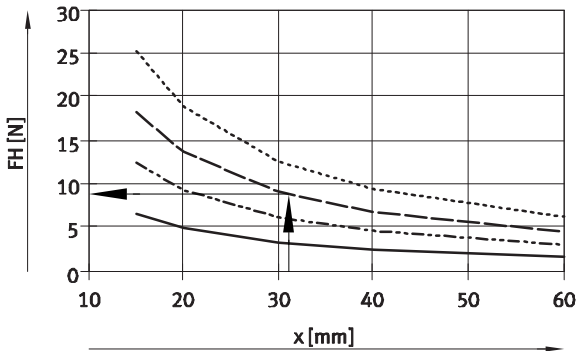

### Torque curve $M$ as a function of opening angle $\alpha$

The drive principle of the gripper jaws means that the torque is not constant within the opening angle. The percentage of torque available in each case can be seen in the graph. An opening angle of  $0^\circ$  means a parallel gripper jaw position.

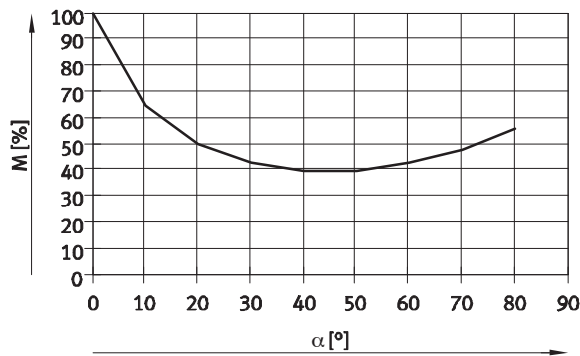

# Radial grippers DHRS

Technical data

## Spring torque $M_F$ as a function of opening angle $\alpha$

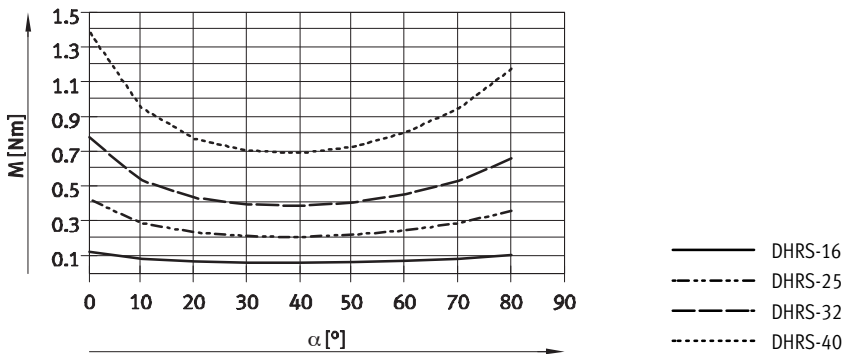

## Determination of the actual gripping torques $M_{Grtotal}$ for DHRS-...-NC as a function of application

The radial gripper with integrated spring type DHRS-...-NC (closing gripping force retention) can be used as:

- single-acting grippers
- grippers with supplementary gripping force and
- grippers with gripping force retention depending on requirements.

In order to calculate the available gripping torque  $M_{Grtotal}$  (per gripper jaw), the data from the graphs for the gripping force  $F_H$  (→ page 10/11),

the torque curve (→ page 12) and the spring torque  $M_F$  (→ page 13) must be combined accordingly.

$$M_{Gr} = F_H * x * M \text{ [%]}$$

$M_{Gr}$  Gripping torque  
 $F_H$  Gripping force  
 $x$  Lever arm  
 $M$  Torque curve

## Application

Single-acting	Supplementary gripping force	Gripping force retention
<ul style="list-style-type: none"> <li>• Gripping with spring force: <math>M_{Grtotal} = M_F</math></li> <li>• Gripping with pressure force: <math>M_{Grtotal} = M_{Gr} - M_F</math></li> </ul>	<ul style="list-style-type: none"> <li>• Gripping with pressure and spring force: <math>M_{Grtotal} = M_{Gr} + M_F</math></li> </ul>	<ul style="list-style-type: none"> <li>• Gripping with spring force: <math>M_{Grtotal} = M_F</math></li> </ul>

# Radial grippers DHRS

Technical data

FESTO

## Dimensions

Download CAD data → [www.festo.com](http://www.festo.com)

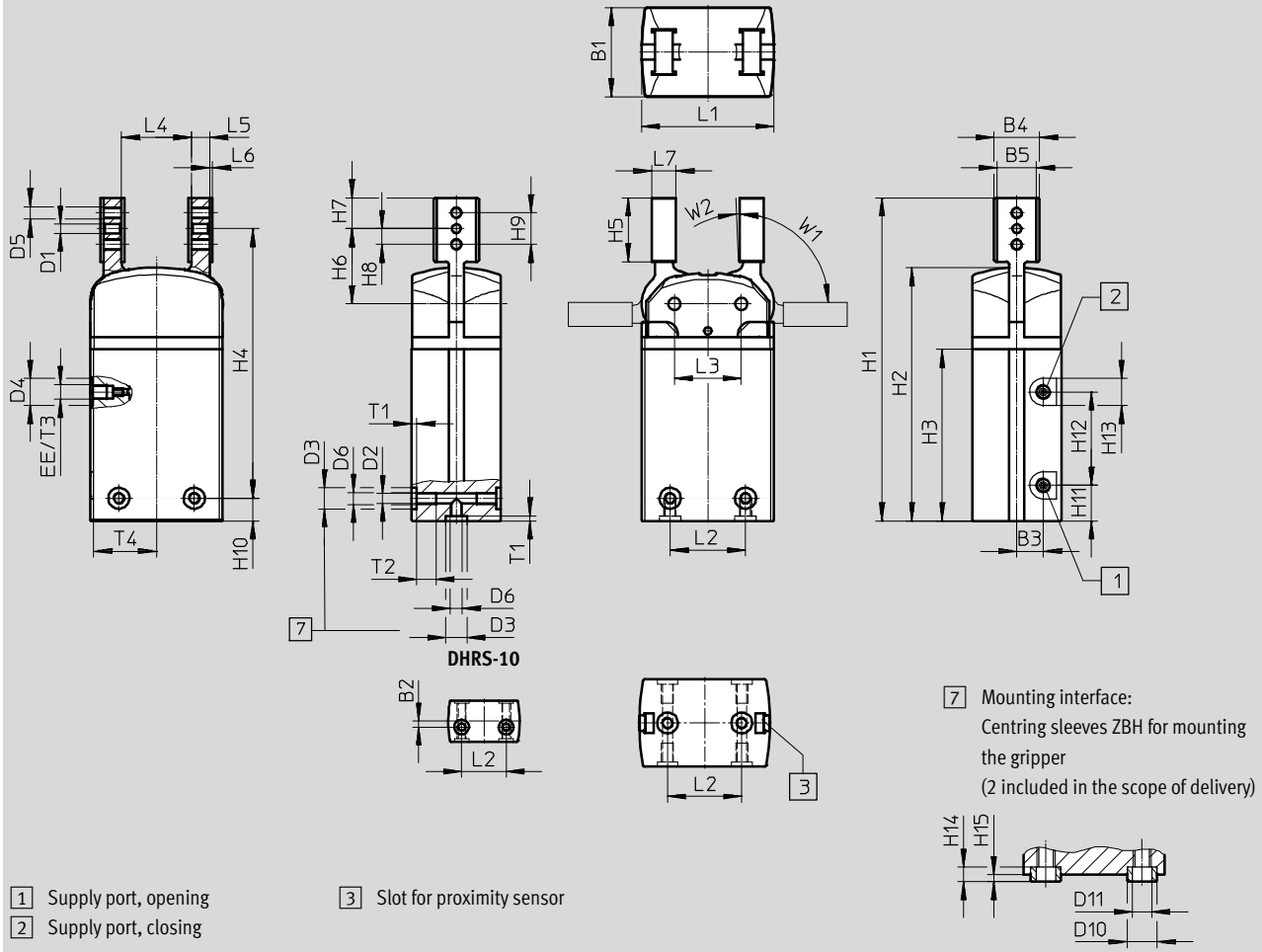

Size	B1	B2 <sup>1)</sup>	B3	B4	B5	D1	D2	D3	D4	D5	D6
[mm]	±0.05				+0.03/ +0.01	∅ H8	∅ +0.1	∅ H8/h7	∅		
10	14	2	2	8.5	6.5	2	2.4	5	7	M2.5	M3
16	19	–	5.8	14	10	2	2.5	5	–	M3	M3
25	29.5	–	8.75	15	13	3	3.3	7	9	M4	M4
32	38	–	11	16	14	4	5.1	9	15	M5	M6
40	49	–	11	24	20	5	6.4	12	15	M6	M8

Size	D10	D11	EE	H1	H2	H3	H4	H5	H6	H7
[mm]	∅ h7	∅					±0.25	±0.2	±0.05	–0.1
10	5	3.2	M3	60.8	46	30.8	42.25	13.8	14.95	6.25
16	5	3.2	M3	88.2	70.5	49	73.7	16.5	19.7	7
25	7	5.3	M5	107.2	84	57	89.45	21.2	24.95	10.25
32	9	6.4	G1/8	128.5	96.2	65	103.5	29.5	32	14
40	12	10.3	G1/8	140	108.4	71.5	108.7	29.5	33.7	13.8

1) Tolerance for centring hole ±0.02 mm; tolerance for thread ±0.1 mm

# Radial grippers DHRS

Technical data

Size [mm]	H8	H9	H10 <sup>2)</sup>	H11	H12	H13	H14	H15	L1	L2 <sup>1)</sup>	L3
							-0.2	-0.3	±0.05		±0.02
10	4	8	12.3	8.8	16	7	2.4	1.2	24	15	12.4
16	4	8	7.5	12.25	23	7	2.4	1.2	33.4	16	17
25	5.25	10.5	7.5	11.8	31	9	3	1.4	44	25	22.2
32	7	14	11	20	25	15	4	1.9	51	29	25.8
40	8	16	17.5	9	46	15	5	2.4	59	33	30

Size [mm]	L4	L5	L6	L7	T1	T2	T3	T4	W1	W2
		±0.05			+0.1	+1	+0.5		±2°	+3°
10	12	4	0.5	5	1.2	through	3.5	11.6	90	2
16	21	4	1	6	1.2	5.8	4.5	16	90	2
25	23.2	6	1	8	1.6	6.4	4.5	21	90	2
32	24.8	8	1	10	2.1	12.9	6.5	24	90	2
40	29.6	10	1	12	2.6	13.4	6	28.4	90	2

1) Tolerance for centring hole ±0.02 mm, tolerance for thread ±0.1 mm

2) Tolerance for centring hole -0.05 mm, tolerance for thread ±0.1 mm

Ordering data			
Size [mm]	Double-acting without compression spring		Single-acting or with gripping force retention
	Part No.	Type	Closing Part No. Type
10	<b>1310159</b>	<b>DHRS-10-A</b>	-
16	<b>1310160</b>	<b>DHRS-16-A</b>	<b>1310161</b> <b>DHRS-16-A-NC</b>
25	<b>1310162</b>	<b>DHRS-25-A</b>	<b>1310163</b> <b>DHRS-25-A-NC</b>
32	<b>1310164</b>	<b>DHRS-32-A</b>	<b>1310165</b> <b>DHRS-32-A-NC</b>
40	<b>1310166</b>	<b>DHRS-40-A</b>	<b>1310167</b> <b>DHRS-40-A-NC</b>

# Radial grippers DHRS



Accessories



**Adapter kit**  
HAPG, HAPS, HMSV

Material:  
Wrought aluminium alloy  
Free of copper and PTFE  
RoHS-compliant

 Note  
The kit includes the individual mounting interface as well as the necessary mounting material.

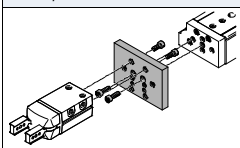
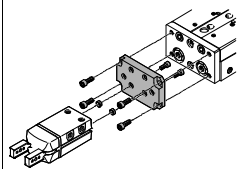
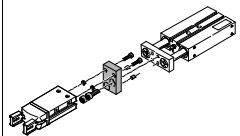
Permissible drive/gripper combinations with adapter kit						Download CAD data → <a href="http://www.festo.com">www.festo.com</a>	
Combination	Drive Size	Gripper Size	Mounting option		Adapter kit		
					CRC <sup>1)</sup>	Part No.	Type
	DGSL	DHRS			HMSV		
	8, 10	10	■	■	2	548784	HMSV-54
	12, 16	16	■	■		548785	HMSV-55
	20, 25	25, 32	■	■		548786	HMSV-56
	SLT	DHRS			HAPS		
	10	10	■	–	2	178448	HAPS-2
	16	16	■	–		178449	HAPS-3
	20	25	■	–		178450	HAPS-4
	25	32	■	–		178451	HAPS-5
	DPZ	DHRS			HAPG		
	10, 16	16	■	–	2	163250	HAPG-1
	16	25	■	–		163251	HAPG-2
	20	25	■	–		163252	HAPG-3
	25, 32	32	■	–		163253	HAPG-4

1) Corrosion resistance class CRC 2 to Festo standard FN 940070  
Moderate corrosion stress. Indoor applications in which condensation may occur. External visible parts with primarily decorative requirements for the surface and which are in direct contact with the ambient atmosphere typical for industrial applications.



# Radial grippers DHRS

Accessories

FESTO

**Adapter kit**  
DHAA, HAPG, HMSV, HMVA,

Material:  
Wrought aluminium alloy  
Free of copper and PTFE  
RoHS-compliant

 Note  
The kit includes the individual mounting interface as well as the necessary mounting material.

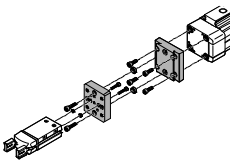
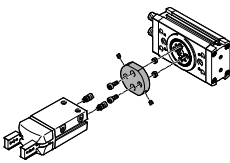
Permissible drive/gripper combinations with adapter kit					Download CAD data → <a href="http://www.festo.com">www.festo.com</a>		
Combination	Drive	Gripper	Mounting option		Adapter kit		
			Size	Size	CRC <sup>1)</sup>	Part No.	Type
DGP..., DGE..., DGEA/DHRS	DG...	DHRS				HMVA, HAPG, HMSV	
	Direct mounting						
	18 <sup>2)</sup> , 25 <sup>3)</sup>	10	■	■	2	196788	HMVA-DLA18/25
						192706	HAPG-37-S1
	40 <sup>3)</sup>	10	■	■		196790	HMVA-DLA40
						192706	HAPG-37-S1
	18 <sup>2)</sup> , 25 <sup>3)</sup>	16	■	■		196788	HMVA-DLA18/25
						192705	HAPG-36-S1
	40 <sup>3)</sup>	16	■	■		196790	HMVA-DLA40
						192705	HAPG-36-S1
	18 <sup>2)</sup> , 25 <sup>3)</sup>	25	■	■		196788	HMVA-DLA18/25
						193922	HAPG-37-S4
	40 <sup>3)</sup>	25	■	■		196790	HMVA-DLA40
						193922	HAPG-37-S4
	Dovetail mounting						
	18 <sup>2)</sup> , 25	16	■	■	2	196788	HMVA-DLA18/25
						177767	HMSV-27
	40	16	■	■		196790	HMVA-DLA40
						177767	HMSV-27
18 <sup>2)</sup> , 25	25	■	■	196788		HMVA-DLA18/25	
				177768		HMSV-28	
40	25	■	■	196790		HMVA-DLA40	
				177768		HMSV-28	
40	32	■	■	196790		HMVA-DLA40	
				177769		HMSV-29	
40	40	■	■	196790		HMVA-DLA40	
				177770		HMSV-30	
DRRD/DHRS	DRRD	DHRS				DHAA	
	8	10	■	■	2	2816591	DHAA-G-Q11-8-B2/B3-10
	10	10	■	■		2816068	DHAA-G-Q11-10-B2/B3-10
	12	10	■	■		2814790	DHAA-G-Q11-12-B2/B3-10
	12	16	■	■		2811183	DHAA-G-Q11-12-B2/B3-16
	16	16	■	■		1979085	DHAA-G-Q11-16-B2/B3-16
	16	25	■	■		1978889	DHAA-G-Q11-16-B2/B3-25
	20	25	■	■		1978443	DHAA-G-Q11-20-B2/B3-25
	20	32	■	■		1979912	DHAA-G-Q11-20-B2/B3-32
	25	25	■	■		1801802	DHAA-G-Q11-25-B2/B3-25
	25	32	■	■		1802969	DHAA-G-Q11-25-B2/B3-32
	32	32	■	■		1979992	DHAA-G-Q11-32-B2/B3-32
	32	40	■	■		1980014	DHAA-G-Q11-32-B2/B3-40
	35, 40	40	■	■		1980059	DHAA-G-Q11-35/40-B2/B3-40

1) Corrosion resistance class CRC 2 to Festo standard FN 940070  
Moderate corrosion stress. Indoor applications in which condensation may occur. External visible parts with primarily decorative requirements for the surface and which are in direct contact with the ambient atmosphere typical for industrial applications.

2) Only for DGEA-...

3) Only for DGE.../DGP

# Radial grippers DHRS

Accessories



**Adapter kit**  
**DHAA, HAPG**

Material:  
Wrought aluminium alloy  
Free of copper and PTFE  
RoHS-compliant

 Note  
The kit includes the individual mounting interface as well as the necessary mounting material.

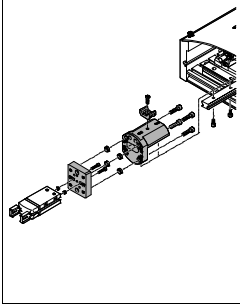
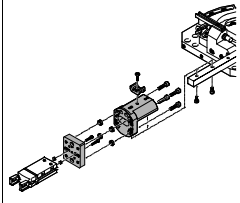
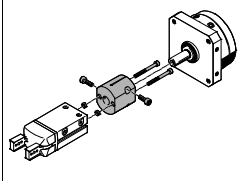
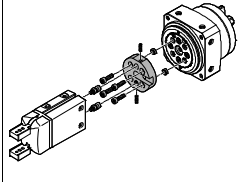
Permissible drive/gripper combinations with adapter kit						Download CAD data → <a href="http://www.festo.com">www.festo.com</a>	
Combination	Drive	Gripper	Mounting option		Adapter kit		
			Size	Size	CRC <sup>1)</sup>	Part No.	Type
<b>HSP/DHRS</b>	HSP	DHRS			HAPG		
	12	10	■	–	2	192709	HAPG-60-S1
						540881	HAPG-70-B
	16	10	■	–		192706	HAPG-37-S1
						540882	HAPG-71-B
	16	16	■	–		192705	HAPG-36-S1
				540882	HAPG-71-B		
	25	16	■	–	192705	HAPG-36-S1	
					540883	HAPG-72-B	
	25	25	■	–	193922	HAPG-37-S4	
					540883	HAPG-72-B	
<b>HSW/DHRS</b>	HSW	DHRS			HAPG		
	12, 16	10	■	–	2	192706	HAPG-37-S1
						540882	HAPG-71-B
	12, 16	16	■	–		192705	HAPG-36-S1
					540882	HAPG-71-B	
<b>DSM/DHRS</b>	DSM-...-FW	DHRS			HAPG		
	6, 8, 10	10	■	■	2	187568	HAPG-34
	DSM-...	DHRS			HAPG		
	12	16	■	■	2	163266	HAPG-17
	16	16	■	■		163267	HAPG-18
	16	25	■	■		163268	HAPG-19
	25	25	■	■		163269	HAPG-20
	25	32	■	■		163270	HAPG-21
	32	32	■	■		163271	HAPG-22
<b>DSM-...-HD/DHRS</b>	DSM-...-HD	DHRS			DHAA		
	12	16	■	■	2	8072157	DHAA-G-R3-12-B18-10
	12	10	■	■		8072172	DHAA-G-R3-12-B20-10
	16	16	■	■		8071917	DHAA-G-R3-16-B18-10
	16	25	■	■		8079173	DHAA-G-R3-16-B18-16
	25	25	■	■		8071956	DHAA-G-R3-25-B18-16
	25	32	■	■		8079201	DHAA-G-R3-25-B20-32
	32	32	■	■		8079208	DHAA-G-R3-32-B18-25
	32	40	■	■		8079212	DHAA-G-R3-32-B20-40

1) Corrosion resistance class CRC 2 to Festo standard FN 940070  
Moderate corrosion stress. Indoor applications in which condensation may occur. External visible parts with primarily decorative requirements for the surface and which are in direct contact with the ambient atmosphere typical for industrial applications.

# Radial grippers DHRS



Accessories



**Adapter kit**  
**HAPG, HMSV**

Material:  
Wrought aluminium alloy  
Free of copper and PTFE  
RoHS-compliant

 Note  
The kit includes the individual mounting interface as well as the necessary mounting material.

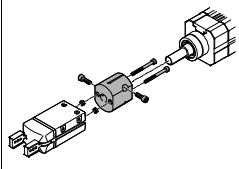
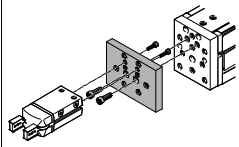
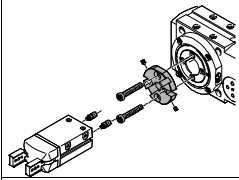
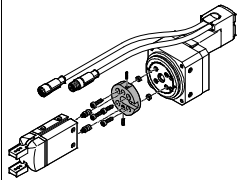
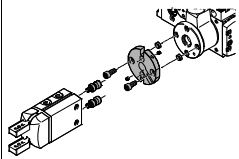
Permissible drive/gripper combinations with adapter kit						Download CAD data → <a href="http://www.festo.com">www.festo.com</a>	
Combination	Drive	Gripper	Mounting option		CRC <sup>1)</sup>	Part No.	Type
							
<b>DSL/DHRS</b>	<b>DSL</b>	<b>DHRS</b>			<b>HAPG</b>		
	16	16	■	■	2	<b>163266</b>	<b>HAPG-17</b>
	20	16	■	■		<b>163267</b>	<b>HAPG-18</b>
	20	25	■	■		<b>163268</b>	<b>HAPG-19</b>
	25	25	■	■		<b>163269</b>	<b>HAPG-20</b>
	25	32	■	■		<b>163270</b>	<b>HAPG-21</b>
	32	32	■	■		<b>163271</b>	<b>HAPG-22</b>
<b>EGSL/DHRS</b>	<b>EGSL</b>	<b>DHRS</b>			<b>HMSV</b>		
	35	10	■	■	2	<b>548784</b>	<b>HMSV-54</b>
	45, 55	16	■	■		<b>1088262</b>	<b>HMSV-70</b>
	75	25, 32	■	■		<b>548785</b>	<b>HMSV-55</b>
						<b>548786</b>	<b>HMSV-56</b>
<b>ERMB/DHRS</b>	<b>ERMB</b>	<b>DHRS</b>			<b>HAPG</b>		
	20	25	■	■	2	<b>184479</b>	<b>HAPG-SD2-3</b>
	25	25	■	■		<b>184482</b>	<b>HAPG-SD2-6</b>
	20	32	■	■		<b>184480</b>	<b>HAPG-SD2-4</b>
	25	32	■	■		<b>184483</b>	<b>HAPG-SD2-7</b>
	32	32	■	■		<b>184485</b>	<b>HAPG-SD2-9</b>
	32	40	■	■		<b>184486</b>	<b>HAPG-SD2-10</b>
<b>ERMO/DHRS</b>	<b>ERMO</b>	<b>DHRS</b>			<b>DHAA</b>		
	12	16	■	■	2	<b>8072157</b>	<b>DHAA-G-R3-12-B18-10</b>
	12	10	■	■		<b>8072172</b>	<b>DHAA-G-R3-12-B20-10</b>
	16	16	■	■		<b>8071917</b>	<b>DHAA-G-R3-16-B18-10</b>
	16	25	■	■		<b>8079173</b>	<b>DHAA-G-R3-16-B18-16</b>
	25	25	■	■		<b>8071956</b>	<b>DHAA-G-R3-25-B18-16</b>
	25	32	■	■		<b>8079201</b>	<b>DHAA-G-R3-25-B20-32</b>
	32	32	■	■		<b>8079208</b>	<b>DHAA-G-R3-32-B18-25</b>
	32	40	■	■		<b>8079212</b>	<b>DHAA-G-R3-32-B20-40</b>
<b>EHMB/DHRS</b>	<b>EHMB</b>	<b>DHRS</b>			<b>HAPG</b>		
	20	32	■	■	2	<b>184485</b>	<b>HAPG-SD2-9</b>
	20	40	■	■		<b>184486</b>	<b>HAPG-SD2-10</b>
	25, 32	40	■	■		<b>526027</b>	<b>HAPG-SD2-21</b>

1) Corrosion resistance class CRC 2 to Festo standard FN 940070

Moderate corrosion stress. Indoor applications in which condensation may occur. External visible parts with primarily decorative requirements for the surface and which are in direct contact with the ambient atmosphere typical for industrial applications.

# Radial grippers DHRS

Accessories

**FESTO**

Ordering data						
	For size [mm]	Description	Weight [g]	Part No.	Type	PU <sup>1)</sup>
Centring sleeve ZBH <span style="float: right;">Technical data → Internet: zbh</span>						
	10, 16	For centring the gripper during mounting	1	<b>189652</b>	<b>ZBH-5</b>	10
	25		1	<b>186717</b>	<b>ZBH-7</b>	
	32		1	<b>150927</b>	<b>ZBH-9</b>	
	40		1	<b>189653</b>	<b>ZBH-12</b>	

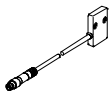

1) Packaging unit

Ordering data						
Type	For size	Weight [g]	Part No.	Type		
Position sensor SMH-S1 <span style="float: right;">Technical data → Internet: smh-s1</span>						
	10	20	<b>175712</b>	<b>SMH-S1-HGR10</b>		

## Signal converter SVE4 for position sensor SMH-S1

- Converts analogue signals into switching points
- Switching function freely programmable with teach-in
- Threshold value, hysteresis or window comparator

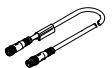
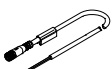
Ordering data						
Type	For size	Input connection	Output connection	Switching output	Weight [g]	Part No. Type
Signal converter SVE4 <span style="float: right;">Technical data → Internet: sve4</span>						
	10	Socket M8x1, 4-pin	Plug M8x1, 4-pin	2x PNP	19	<b>544216</b> <b>SVE4-HS-R-HM8-2P-M8</b>
				2x NPN		<b>544219</b> <b>SVE4-HS-R-HM8-2N-M8</b>

Ordering data – Connecting cables						Technical data → Internet: nebu
	Electrical connection, left	Electrical connection, right	Cable length [m]	Part No.	Type	
Connection between position sensor and signal converter						
	Straight socket, M8x1, 4-pin	Straight plug, M8x1, 4-pin	2.5	<b>554035</b>	<b>NEBU-M8G4-K-2.5-M8G4</b>	
Connection between signal converter and controller						
	Straight socket, M8x1, 4-pin	Cable, open end, 4-wire	2.5	<b>541342</b>	<b>NEBU-M8G4-K-2.5-LE4</b>	
			5	<b>541343</b>	<b>NEBU-M8G4-K-5-LE4</b>	
	Angled socket, M8x1, 4-pin	Cable, open end, 4-wire	2.5	<b>541344</b>	<b>NEBU-M8W4-K-2.5-LE4</b>	
			5	<b>541345</b>	<b>NEBU-M8W4-K-5-LE4</b>	



# Radial grippers DHRS

Accessories

FESTO

## Proximity sensor for size 16 ... 40

Ordering data – Proximity sensors for T-slot, magneto-resistive						Technical data → Internet: smt	
	Type of mounting	Electrical connection, connection direction	Switching output	Cable length [m]	Part No.	Type	
N/O contact							
	Insertable in the slot lengthwise	Cable, 3-wire, lateral	PNP	2.5	547859	SMT-8G-PS-24V-E-2,5Q-OE	
		Plug M8x1, 3-pin, lateral		0.3	547860	SMT-8G-PS-24V-E-0,3Q-M8D	
		Cable, 3-wire, lateral	NPN	2.5	8065028	SMT-8G-NS-24V-E-2,5Q-OE	
		Plug M8x1, 3-pin, lateral		0.3	8065027	SMT-8G-NS-24V-E-0,3Q-M8D	

Ordering data – Connecting cables					Technical data → Internet: nebu	
	Electrical connection, left	Electrical connection, right	Cable length [m]	Part No.	Type	
	Straight socket, M8x1, 3-pin	Cable, open end, 3-wire	2.5	541333	NEBU-M8G3-K-2.5-LE3	
			5	541334	NEBU-M8G3-K-5-LE3	
	Angled socket, M8x1, 3-pin	Cable, open end, 3-wire	2.5	541338	NEBU-M8W3-K-2.5-LE3	
			5	541341	NEBU-M8W3-K-5-LE3	

## Position transmitter

The position transmitter continuously senses the position of the piston.  
It has an analogue output with an output signal in proportion to the piston position.

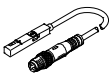
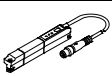
Ordering data – Position transmitters for T-slot							Technical data → Internet: position transmitter		
	For size	Position measuring range	Analogue output		Type of mounting	Electrical connection	Cable length [m]	Part No.	Type
			[V]	[mA]					
	16 ... 40	0 ... 40	0 ... 10	–	Insertable in slot from above	Plug M8x1, 4-pin, in-line	0.3	553744	SMAT-8M-U-E-0,3-M8D
			–	4 ... 20					
	32, 40	0 ... 50	–	4 ... 20	Insertable in slot from above	Plug M8x1, 4-pin, in-line	0.3	1531265	SDAT-MHS-M50-1L-SA-E-0,3-M8

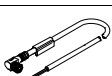
Ordering data – Connecting cables					Technical data → Internet: nebu	
	Electrical connection, left	Electrical connection, right	Cable length [m]	Part No.	Type	
	Straight socket, M8x1, 4-pin	Cable, open end, 4-wire	2.5	541342	NEBU-M8G4-K-2.5-LE4	
			5	541343	NEBU-M8G4-K-5-LE4	
	Angled socket, M8x1, 4-pin	Cable, open end, 4-wire	2.5	541344	NEBU-M8W4-K-2.5-LE4	
			5	541345	NEBU-M8W4-K-5-LE4	

# Festo - Your Partner in Automation



**1 Festo Inc.**  
5300 Explorer Drive  
Mississauga, ON L4W 5G4  
Canada

**Festo Customer Interaction Center**  
Tel: 1 877 463 3786  
Fax: 1 877 393 3786  
Email: [customer.service.ca@festo.com](mailto:customer.service.ca@festo.com)



**2 Festo Pneumatic**  
Av. Ceylán 3,  
Col. Tequesquináhuac  
54020 Tlalneantla,  
Estado de México

**Multinational Contact Center**  
01 800 337 8669  
[ventas.mexico@festo.com](mailto:ventas.mexico@festo.com)



**3 Festo Corporation**  
1377 Motor Parkway  
Suite 310  
Islandia, NY 11749

**Festo Customer Interaction Center**  
1 800 993 3786  
1 800 963 3786  
[customer.service.us@festo.com](mailto:customer.service.us@festo.com)



**4 Regional Service Center**  
7777 Columbia Road  
Mason, OH 45040

Connect with us



[www.festo.com/socialmedia](http://www.festo.com/socialmedia)



[www.festo.com](http://www.festo.com)

Subject to change