

Switches

Solid State Switches



Applicable Actuators

D-F9	Series LXF*, LXP, LXS
D-Y7GL	Series LJ1 (non-standard motor)

* Cannot be mounted on Series LXF with ball screw specification.

Auto Switch Specifications

Auto switch part no.	D-F9N	D-F9P	D-F9B	D-F9G	D-F9H
Contact	N.O. (A contact)			N.C. (B contact)	
Electrical entry	In-line				
Wiring type	3 wire		2 wire	3 wire	
Output type	NPN	PNP	—	NPN	PNP
Applicable load	IC circuit, Relay, PLC		24VDC relay, PLC	IC circuit, Relay, PLC	
Power supply voltage	5, 12, 24VDC (4.5 to 28V)			5, 12, 24VDC (4.5 to 28V)	
Current consumption	10mA or less			10mA or less	
Load voltage	28VDC or less	—	24VDC (10 to 28VDC)	28VDC or less	—
Load current	40mA or less	80mA or less	5 to 40mA	40mA or less	80mA or less
Internal voltage drop	1.5V or less (0.8V or less at load current of 10mA)	0.8V or less	0.4V or less	1.5V or less (0.8V or less at load current of 10mA)	0.8V or less
Leakage current	100µA or less at 24VDC		80mA or less	100µA or less at 24VDC	
Indicator light	Red LED lights up when ON			Red LED lights up when OFF	

Auto switch internal circuits

Lead wire colors inside [] are those prior to conformity with IEC standards.

D-F9G, D-Y7GL

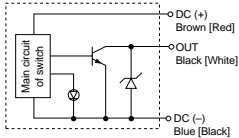

D-F9P, D-F9H

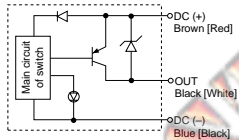

D-F9B

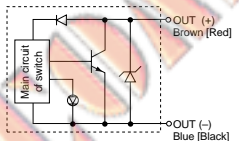

- Lead wire — Oil resistant heavy duty vinyl cord, ø2.7, 0.15mm² x 3 wire (Brown, Black, Blue [Red, White, Black]), 0.18mm² x 2 wire (Brown, Blue [Red, Black])
- Insulation resistance — 50MΩ or more at 500VDC (between lead wire and case)
- Withstand voltage — 1000VAC for 1 min. (between lead wire and case)
- Indication light — Lights when ON
- Ambient temperature — -10 to 60°C
- Operating time — 1ms or less
- Impact resistance — 1000m/s²

Auto switch part no.	D-Y7GL
Contact	N.C. (B contact)
Electrical entry	In-line
Wiring type	3 wire
Output type	NPN
Applicable load	IC circuit, Relay, PLC
Power supply voltage	5, 12, 24VDC (4.5 to 28V)
Current consumption	10mA or less
Load voltage	28VDC or less
Load current	40mA or less
Internal voltage drop	1.5V or less (0.8V or less at load current of 10mA)
Leakage current	100µA or less at 24VDC
Indicator light	Red LED lights up when OFF

Switches

Solid State Switch Connection and Examples

Basic Wiring

3 wire, NPN

(When the switch power supply and load power supply are the same)

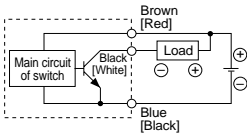

(When the switch power supply and load power supply are separate)

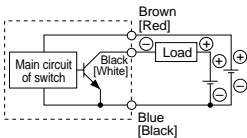

3 wire, PNP

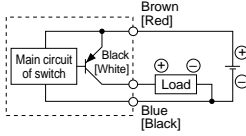

2 wire

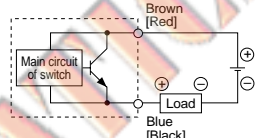
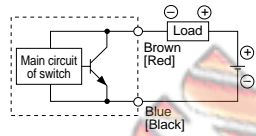

Examples of Connection to PLC

Sink input specifications, 3 wire, NPN

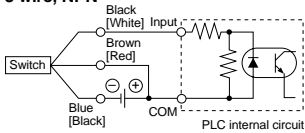

2 wire

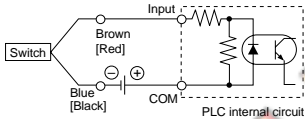

Source input specifications, 3 wire, PNP

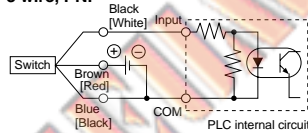

2 wire

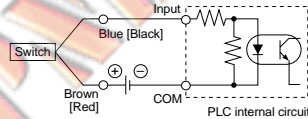

Connect according to the applicable PLC input specifications, as the connection method will vary depending on the PLC input specifications.

Connection Examples for AND (Series) and OR (Parallel)

3 wire, AND connection for NPN output

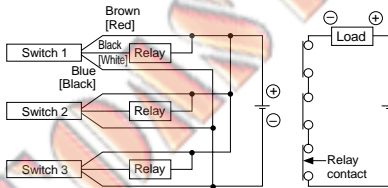

3 wire, OR connection for NPN output

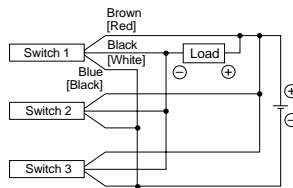

2 wire with 2 switch AND connection

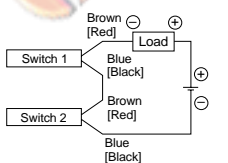

When two switches are connected in series, a load may malfunction because the load voltage will decline when in the ON state. The indicator lights will light up when both of the switches are in the ON state.

Load voltage at ON = Power supply voltage - Residual voltage x 2 pcs.
= 24V - 4V x 2 pcs.
= 16V

Example: Power supply voltage is 24VDC.
Internal voltage drop in switch is 4V.

2 wire with 2 switch OR connection

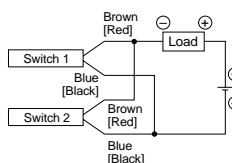

When two switches are connected in parallel, malfunction may occur because the load voltage will increase when in the OFF state.

Load voltage at OFF = Leakage current x 2 pcs. x Load impedance
= 1mA x 2pcs. = 3kΩ
= 6V

Example: Load impedance is 3kΩ.
Leakage current from switch is 1mA.

LG1

LG1

LG1

LG1

LC6D/LC6C

Switches

Switches

Proximity Switches

Applicable switch models

Applicable model	Model type	Part no.	Switch type	
LXF LXS	G	GXL-8F	Standard	N.O. (A contact) 3 wire
	GD	GXL-8FI	Varying frequencies	N.O. (A contact) 3 wire
	GB	GXL-8FB	Standard	N.C. (B contact) 3 wire
	GDB	GXL-8FIB	Varying frequencies	N.C. (B contact) 3 wire
	GU	GXL-8FU	Standard	N.O. (A contact) 2 wire
	GUB	GXL-8FUB	Standard	N.C. (B contact) 2 wire

Switch specifications (SUNX Corporation)

Part no.		GXL-8F(I)(B)	GXL-8FU	GXL-8FUB
Repeatability		Direction of detecting axis, Perpendicular to detecting axis: 0.04mm or less		
Power supply voltage		12 to 24VDC $\pm 10\%$, Ripple P-P 10% or less		
Current consumption		15mA	0.8mA or less (when output is OFF)	
Output		NPN Maximum load current: 100mA Maximum applied voltage: 30VDC Residual voltage: 1V or less	2 wire solid state DC Load current: 3 to 70mA Residual voltage: 3V or less	
Maximum response frequency		500Hz	1kHz	
Indicator light		Red LED (lights up when ON)	Green LED (stable detection) Red LED (unstable detection)	
Environmental resistance	Ambient temperature	-10° to 55° C		-25° to 70° C
	Ambient humidity	45 to 85% RH		
	Noise resistance	Power line: 240Vp, pulse width of 0.5 μ s		
Detecting distance fluctuation	Temperature characteristics	Within $\pm 15\%$ – 10% of detecting distance at 20° C within ambient temperature range		
	Voltage characteristics	Within $\pm 2\%$ with $\pm 10\%$ fluctuation of operating voltage		
Cable		0.08mm 3 wire heavy duty cable 1m	0.15mm 2 wire heavy duty cable 1m	

Proximity switch internal circuit

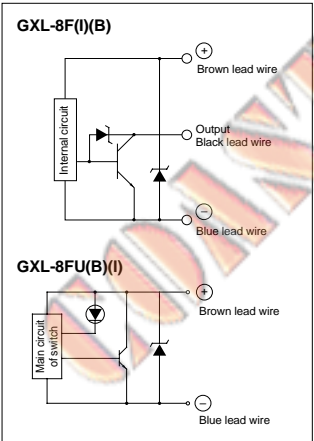

Proximity Switch/Switch Plate Mounting

Be sure to use the mounting screws included, and mount the proximity switch as shown in the drawing to the right.

Mount the switch plate as shown below. Always use the proper tightening torque and use a thread locking agent on screws to prevent loosening. The switch body is made of PBT and acrylic resin. Select a thread locking agent that will not affect these materials.

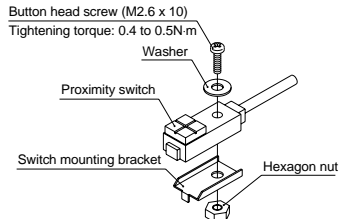

Thin head screw (M3 x 4)
Tightening torque: 0.38 to 0.42N-m

Round head screw (M2.5 x 5)
Tightening torque: 0.38 to 0.42N-m

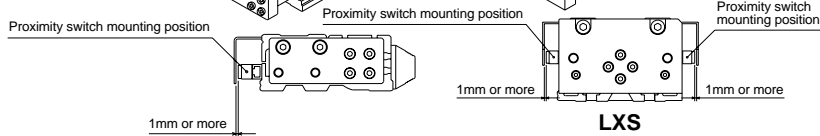
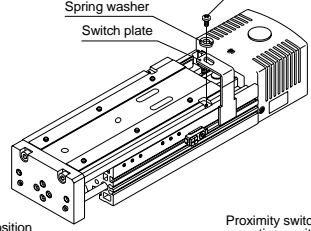
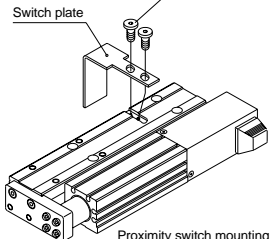

Switches

Photo Micro Sensor

Standard Photo Micro Sensor for Home Position (OMRON Corporation)

Rating

Power supply voltage	5 to 24VDC $\pm 10\%$, Ripple (p-p) 10% or less		
Current consumption	35mA or less		
Control output	5 to 24VDC load current (Ic) 100mA, Residual voltage 0.8V or less Load current (Ic) 40mA, Residual voltage 0.4V or less		
Ambient temperature	Operation: -25° to 55° C (When stored: -30° to 80° C)		
Ambient humidity	Operation: 5 to 85%RH (When stored: 5 to 95%RH)		
Part no.	EE-SX672 equivalent	EE-SX673 equivalent	EE-SX674
Applicable actuator	LXF	LXP, LXS	LG1 (non-standard motor)

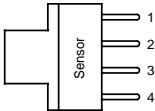

Terminal arrangement

1	Brown	Vcc	⊕
2	White	L*	
3	Black	OUTPUT	
4	Blue	GND (OV)	⊖

* Normally ON when light is blocked.
However, if the (L) terminal and (⊕) terminal are shorted, it changes to ON when light enters.

Output level circuit

Operating condition of output transistor	ON when light enters	ON when light is blocked
Output circuit		
Time chart	<p>(“L” and “+” shorted)</p> <p>Light enters</p> <p>Light blocked</p> <p>Lighted indicator light (Red) Light ON</p> <p>Light Off</p> <p>Output Transistor ON</p> <p>OFF</p> <p>Load 1 (Relay) Operate</p> <p>Return</p> <p>Load 2 H</p> <p>L</p>	<p>(“L” and “+” open)</p> <p>Light enters</p> <p>Light blocked</p> <p>Lighted indicator light (Red) Light ON</p> <p>Light Off</p> <p>Output Transistor ON</p> <p>OFF</p> <p>Load 1 (Relay) Operate</p> <p>Return</p> <p>Load 2 H</p> <p>L</p>

LG1

LG1

LC1

LX

LC6D/LC6C

Switches